



LogBox 3G

INSTRUCTION MANUAL V1.2x



Applies to devices with firmware version starting with V1.2x.





1.	SAFETY ALERTS.....	4
2.	INTRODUCTION.....	5
3.	DISPLAY AND NAVIGATION - HMI.....	6
3.1	DISPLAY INFORMATION.....	6
3.2	OPERATION KEYS.....	7
3.3	NAVIGATION SCREENS.....	7
3.3.1	HOME SCREENS.....	8
3.3.2	GENERAL NAVIGATION SCREENS.....	8
4.	BACKUP BATTERIES (INTERNAL UPS).....	15
5.	INPUT SIGNAL READING.....	16
5.1	ANALOG INPUTS.....	16
5.1.1	MEASUREMENT AND INDICATION OF INPUT TYPES.....	17
5.2	DIGITAL INPUT.....	19
5.2.1	PULSE COUNT.....	19
5.2.2	EVENT LOG.....	20
5.2.3	LOG CONTROL.....	20
6.	DIGITAL OUTPUT.....	21
7.	DATA LOGGING.....	22
8.	ALARMS.....	24
9.	DEVICE DATE/TIME.....	25
10.	COMMUNICATING WITH NOVUS CLOUD.....	26
11.	SMS.....	27
11.1	EVENTS.....	27
11.2	COMMANDS.....	27
11.2.1	SYMBOLS.....	27
11.2.2	COMMAND LIST.....	28
11.3	ERROR AND SUCCESS MESSAGES.....	29
11.4	OTHER EXAMPLES.....	29
12.	GPS.....	32
13.	CONFIGURATION SOFTWARE.....	33
13.1	CONFIGURING LOGBOX 3G WITH NXPERIENCE.....	33
13.1.1	GENERAL PARAMETERS.....	33
13.1.1.1	INFORMATION.....	33
13.1.1.2	INTERFACES.....	33
13.1.1.3	HMI.....	33
13.1.1.4	CLOCK.....	34
13.1.2	COMMUNICATION PARAMETERS.....	34
13.1.2.1	NOVUS CLOUD.....	34
13.1.2.2	MOBILE NETWORK.....	34
13.1.2.3	SMS.....	34
13.1.3	ANALOG CHANNEL PARAMETERS.....	35
13.1.3.1	INFORMATION.....	35
13.1.3.2	CUSTOM CALIBRATION.....	36
13.1.4	DIGITAL CHANNEL PARAMETERS.....	36
13.1.4.1	"PULSE COUNT" MODE.....	36
13.1.4.2	"EVENT LOGGING" OR "LOG CONTROL" MODE.....	38
13.1.5	GENERAL CHANNEL PARAMETERS.....	39
13.1.6	CONTACTS TO SEND SMS.....	39
13.1.6.1	PHONEBOOK.....	39
13.1.6.2	GROUPS.....	40
13.1.7	ALARM CONFIGURATION.....	40
13.1.7.1	GENERAL.....	41
13.1.8	DATA LOG CONFIGURATION.....	41
13.1.8.1	LOGS.....	41
13.1.8.2	START MODE.....	41
13.1.8.3	END MODE.....	42
13.1.8.4	PARAMETERS TO LOG/PUBLISH.....	42
13.1.9	FINALIZATION PARAMETERS.....	43
13.1.9.1	CONFIGURATION.....	43
13.1.9.2	EXTRAS.....	43
13.2	DIAGNOSTICS.....	44
13.2.1	LOGS.....	44
13.2.1.1	LOG STATUS.....	44

13.2.1.2	BY SOFTWARE	44
13.2.2	CHANNELS	45
13.2.3	ALARMS	45
13.2.4	INTERFACES	46
13.2.4.1	CELLULAR	46
13.2.4.2	SMS.....	46
13.2.4.3	NOVUS CLOUD	46
13.2.4.4	GPS.....	46
13.2.5	CONNECTION.....	47
13.2.6	MISCELLANEOUS	47
14.	INSTALLATION	48
14.1	MECHANICAL INSTALLATION	48
14.1.1	DIMENSIONS	49
14.1.1.1	DIMENSIONS OF ANTENNAS	49
14.1.2	CONNECTIONS	50
14.2	ELECTRICAL INSTALLATION.....	50
14.2.1	INSTALLATION RECOMMENDATIONS.....	50
14.2.2	SPECIAL PRECAUTIONS	51
14.2.3	ELECTRICAL CONNECTIONS	51
14.2.3.1	POWER SUPPLY	51
14.2.3.2	DIGITAL OUTPUT	51
14.2.3.3	DIGITAL INPUT	52
14.2.3.4	ANALOG INPUTS	52
15.	COMMUNICATION INTERFACES.....	54
15.1	USB INTERFACE.....	54
15.2	MOBILE NETWORK INTERFACE	54
15.2.1	DIAGSIM APPLICATION.....	55
16.	TROUBLESHOOTING	61
16.1	START/STOP MODES.....	61
16.2	CLOCK	61
16.3	ALARM INFORMATION	61
16.4	MOBILE NETWORK INTERFACE	61
16.5	GPS INTERFACE.....	61
16.6	BACKUP POWER BATTERY	61
16.7	ANALOG INPUTS.....	62
16.8	UNREGISTERED ALARMS	62
16.9	LIMIT OF EVENTS SENT BY SMS.....	62
16.10	FIRMWARE RECOVERY.....	62
16.11	PROBLEMS COMMUNICATING WITH THE DEVICE VIA USB INTERFACE OR DURING FIRMWARE UPDATE	62
16.12	FIRMWARE UPDATE	63
17.	TECHNICAL SPECIFICATIONS	66
17.1	SENSOR RANGE AND ACCURACY	67
17.2	CERTIFICATES.....	69
18.	WARRANTY	70

1. SAFETY ALERTS

The symbols below are used throughout this manual to draw the user's attention to important information regarding safety and use of the device.

		
<p>CAUTION Read the manual fully before installing and operating the device.</p>	<p>CAUTION OR HAZARD Risk of electric shock.</p>	<p>ATTENTION Material sensitive to static charge. Check precautions before handling.</p>

Safety recommendations must be followed to ensure user safety and to prevent damage to the device or system. If the device is used in a manner other than that specified in this manual, the safety protections may not be effective.

2. INTRODUCTION

LogBox 3G is a wireless electronic data logger comprising two analog sensors and one digital sensor, respectively called the "analog measurement channel" and the "digital measurement channel". The device has a USB interface for local configuration and a mobile network interface for direct communication with **NOVUS Cloud** (<https://iot2.novusautomation.com/>) and for sending events via SMS.

NOVUS Cloud is a cloud portal that allows for managing logged data and setting remote configurations in the device. Its memory capacity is up to 140,000 logs, ensuring information backup even at times when the communication link may have been lost or during a total power outage. Additionally, it operates with an external power supply, also using internal backup batteries that ensure full operation in eventual power outages.

It features a large display that offers comfortable viewing of measured variables and general device information. The device enclosure has a protective cover for the connections, a sealing ring and base that allows for securing it to a wall or metal surface by means of a bracket with magnetic inserts.

For applications that require geographic positioning, there is a model with GPS interface.

The analog inputs accept any type of temperature sensor, such as thermocouples, Pt100 or sensors for any other magnitudes with current or voltage signals. The digital channel can record the time of events, such as opening a port or counting pulses from a flow sensor. **LogBox 3G** also has the following internal sensors: temperature, battery voltage and external power supply voltage, which can have their values recorded in memory and published on **NOVUS Cloud**, as well as being monitored by USB interface, by SMS or by the display. Its display allows for simultaneously viewing up to three variables, displaying indications about alarms, communication status, enabled channels, backup battery voltage level, among other information.

LogBox 3G also has a buzzer for audible alerts and a digital output that can be used as output for the alarm indication.

When operating, **LogBox 3G** logs data to the memory and publishes directly to **NOVUS Cloud**, with a configurable interval between logs. The logged data and the device configurations can be accessed via desktop or notebook computer connected locally to a USB interface or remotely via **NOVUS Cloud**. For use with computers, **NOVUS** provides the **NXperience** software in the Downloads Area on its website.

3. DISPLAY AND NAVIGATION - HMI

3.1 DISPLAY INFORMATION

LogBox 3G has an LCD display with 3 numerical lines of 4 ½ digits, to display the current value of all enabled channels, as well as the minimum and maximum values thereof. The current value of up to two analog channels or the current value of the digital input can be viewed simultaneously. In addition to channel information, **LogBox 3G** has 14 screens with a variety of information and features and 24 symbols that allow for easy viewing of information and diagnostics.

Following is an illustration of the display with a description of each symbols function:

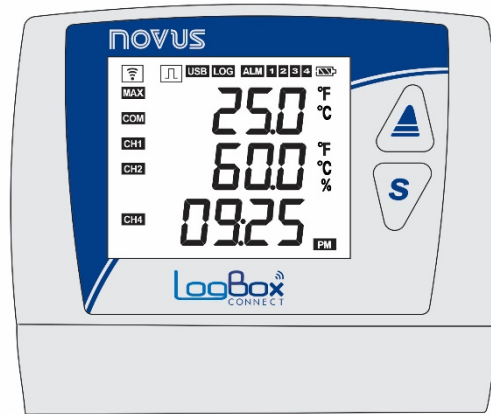









Figure 1 – Display information

- : Informs the status of the mobile network connection. When off, it indicates that the mobile network interface is not running. When flashing, it informs that only SMS services are running. When lit, it informs all mobile network connection services that are operating, and that the device has established a connection with **NOVUS Cloud**. If the symbol is flashing, check the information on the "Info Conn" screen (see [Navigation Screens](#) section) for more information about connection diagnostics.
- : When the digital channel is disabled, it remains off. When set to "Pulse Count" mode, it will remain on. When set in the "Event Logging" or "Log Control" modes, it will remain lit, flashing when an event is detected at the digital input.
- **USB**: Lights up when the USB cable is connected. Turns off when the USB cable is disconnected.
- **LOG**: It remains lit from the moment the device records the first log until the moment it stops logging. When set to "Daily" logging mode, which should start and end daily at a predetermined time, it will remain lit during the configured time. It will flash while logging, turn off at the time of a log and restart.
- **ALM**: Lights up and stays on when entering an alarm condition. Turns off when a new configuration is received or the alarm status is cleared. Indicates to the user that, at some point, an alarm was triggered.
- **1 2 3 4**: Light up while the alarm conditions of the corresponding channels are met: 1 (any alarm configured for analog channel 1), 2 (any alarm configured for analog channel 2), 3 (any alarm configured for internal sensors) and 4 (any alarm configured for the digital channel). When exiting the alarm condition, the flag will be cleared.
- : Indicates the battery voltage level. The symbol will be refreshed in the HMI refresh interval.
 - : Battery charge over 75 %
 - : Battery charge over 50 %
 - : Battery charge over 25 %
 - : Battery below 25 %
- **MAX**: Lights up while information on the "Maximum" values reached in each channel is being viewed on the display.
- **COM**: It flashes to inform the receipt of a valid data packet from one of the available communication interfaces.
- **CH1 CH2 CH4**: Indicates which channels are enabled.
- **MIN**: Lights up while information on the "Minimum" values reached in each channel is being viewed on the display.
- **°F °C**: If the channel unit is set to °F or °C, one of the symbols will light up when the channel is displayed. Otherwise, no unit symbol will be displayed.
- **PM**: If the clock is configured for the 12-hour format, the PM symbol will light up when the clock is displayed and the time is later than 12 pm.



3.2 OPERATION KEYS

For navigation between screens, **LogBox 3G** features two keys: . Each key, depending on the current navigation screen, has two or more functions:

- Quick touch (less than 2 seconds):
 - Proceeds to the next screen if the current screen mnemonic is being displayed.
 - Displays the mnemonic of the current screen again if the screen information is being displayed.
- Long Touch (longer than 2 seconds or held down):
 - Takes an action within the current screen.
- Both keys pressed (longer than 2 seconds or held down):
 - Takes a second action within the current screen.

If the buzzer is active and the configuration allows it to be muted by the keyboard, pressing any key will mute it.

3.3 NAVIGATION SCREENS

To facilitate identification of information on each screen, a mnemonic, which will remain visible for two seconds, will be displayed when a key is pressed. If no key is pressed during this period, the information on the current screen will be displayed. If the  or  keys are pressed while a mnemonic is being displayed, the device will advance to the next screen or return to the previous one, which will be duly specified by their respective mnemonics.

When the device is displaying information on a screen, just tap either of the two keys to make the mnemonic appear again. To access the desired screen, just wait two seconds. The navigation screens will be refreshed during navigation.

LogBox 3G has two home screen options that can be defined as home screen, as shown below. The home screen will remain on the display when the user is not navigating between screens. After 30 seconds without action, the device will return to the home screen. The home screen will be refreshed at the refresh interval configured for the display.

3.3.1 HOME SCREENS











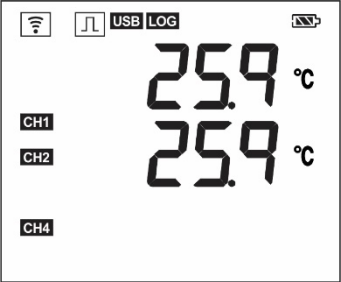

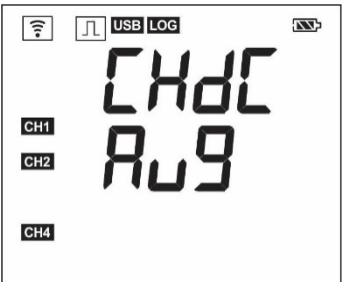
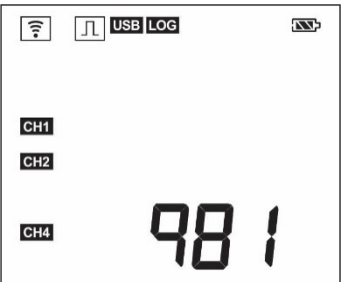

The table below illustrates the screens that can be configured as home screen.

SCREEN	INFORMATION	DESCRIPTION
1. Analog Inputs		<p>Displays the current value of analog channels and the current time.</p> <p>Line 1: Analog channel 1 value. Line 2: Analog channel 2 value. Line 3: Current device time: Hour:Minute.</p>
2. Digital Input a) Pulse Count: Flow Rate		<p>When enabled and configured in "Pulse Count" mode and then configured with the "Average Flow by Acquisition Interval" option (Application parameter / Flow function), it displays the average flow logged within the configured log interval. If it is not configured, this screen will not be displayed.</p> <p>Use the third line of the display to display the logged flow rate.</p>
3. Digital Input b) Pulse Count: Count		<p>When enabled and configured in the "Pulse Count" mode and then configured with the "Acquisition Interval Counting" option (Application parameter / Count function), it displays the logged count within the configured log interval. If it is not configured, this screen will not be displayed.</p> <p>Use the third line of the display to display the logged count.</p>
4. Digital Input c) Pulse Count: Accumulator		<p>When enabled and configured in the "Pulse Count" mode and then set to "Volume since Last Reset" (Application parameter / Flow Rate function) or the option "Accumulated Count Since Last Reset" (Application parameter / Count function), displays the volume or count accumulated since the last digital channel reset. If it is not configured, this screen will not be displayed.</p> <p>Uses the third line of the display to display the accumulated volume or count.</p>
5. Digital Input d) Event Logging or Log Control		<p>When enabled and configured in "Event Logging" or "Log Control" modes, it displays the last event detected at the digital input.</p> <p>Line 1: Edge detected in event: 0 – Falling edge; 1 – Rising edge. Line 2: Day.Month of the event (if the 24-hour format is selected); Month.Day of the event (if the AM/PM format is selected). Line 3: Hour:Minute of the event.</p>

Table 1 – Home Screens

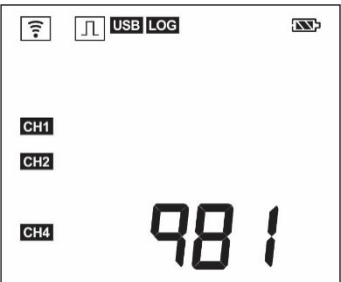





3.3.2 GENERAL NAVIGATION SCREENS



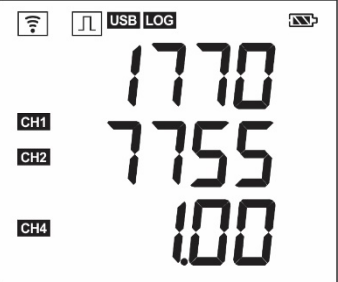



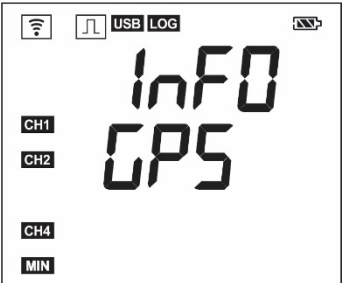
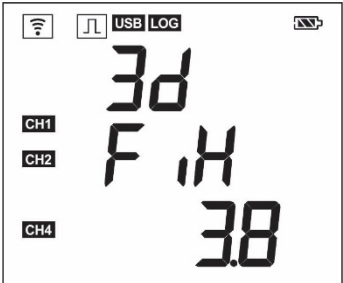

The table below shows all screens, mnemonics and information related thereto, description of information, and key functions on each screen available in the device.

SCREEN	MNEMONIC	INFORMATION	DESCRIPTION	KEY FUNCTIONS
1. Analog Inputs			Displays the current value of analog channels and allows for viewing the maximum and minimum values reached by each channel. Line 1: Analog channel 1 value. Line 2: Analog channel 2 value.	 Key pressed or held: Informs the maximum values reached in each analog channel.  Key pressed or held: Informs the minimum values reached in each analog channel.   Both keys pressed: Clears the minimum and maximum values reached by each analog channel. Displays the "CLR" message upon completing the operation.
2. Digital Input a) Pulse Count: Flow Rate			When enabled and configured in "Pulse Count" mode and then configured with the "Average Flow by Acquisition Interval" option (Application parameter / Flow function), it displays the average flow logged within the configured log interval. If it is not configured, this screen will not be displayed. Use the third line of the display to display the logged flow rate.	 Key pressed or held: No action.  Key pressed or held: No action.   Both keys pressed: No action.
3. Digital Input b) Pulse Count: Count			When enabled and configured in the "Pulse Count" mode and then configured with the "Acquisition Interval Counting" option (Application parameter / Count function), it displays the logged count within the configured log interval. If it is not configured, this screen will not be displayed. Use the third line of the display to display the logged count.	 Key pressed or held: No action.  Key pressed or held: No action.   Both keys pressed: No action.

SCREEN	MNEMONIC	INFORMATION	DESCRIPTION	KEY FUNCTIONS
4. Digital Input c) Pulse Count: Accumulator			<p>When enabled and configured in the "Pulse Count" mode and then set to "Volume since Last Reset" (Application parameter / Flow Rate function) or the option "Accumulated Count Since Last Reset" (Application parameter / Count function), displays the volume or count accumulated since the last digital channel reset. If it is not configured, this screen will not be displayed.</p> <p>Uses the third line of the display to display the accumulated volume or count.</p>	<p> Key pressed or held: Informs the maximum flow reached in the pulse count from the digital input.</p> <p> Key pressed or held: Informs the minimum flow reached in the pulse count from the digital input.</p> <p> Both keys pressed: Clears the minimum and maximum values reached by each analog channel. Displays the "CLR" message upon completing the operation.</p>
5. Digital Input d) Event Logging or Log Control			<p>When enabled and configured in "Event Logging" or "Log Control" modes, it displays the last event detected at the digital input. If this option is not configured, this screen will not be shown.</p> <p>Line 1: Edge detected in event: 0 – Falling edge; 1 – Rising edge.</p> <p>Line 2: Day.Month of the event (if the 24-hour format is selected); Month.Day of the event (if the AM/PM format is selected).</p> <p>Line 3: Hour:Minute of the event.</p>	<p> Key pressed or held: No action.</p> <p> Key pressed or held: No action.</p> <p> Both keys pressed: No action.</p>
6. Internal Temperature (Cold Joint)			<p>Displays the internal device temperature. This temperature will be used for Cold Joint compensation in thermocouple type sensors.</p>	<p> Key pressed or held: No action.</p> <p> Key pressed or held: No action.</p> <p> Both keys pressed: No action.</p>

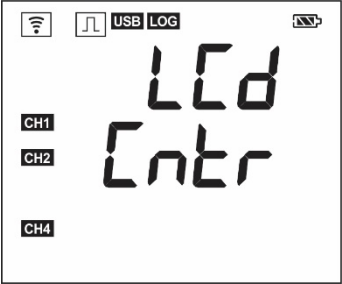
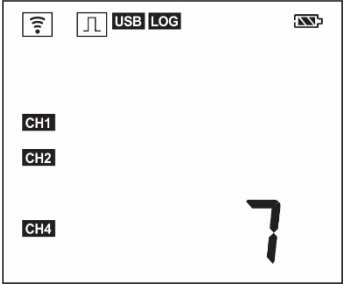
<p>7. Date/Time</p>			<p>Displays the current date and time on the device.</p> <p>Line 1: Day.Month (if the 24-hour format is selected); Month.Day (if the AM/PM format is selected).</p> <p>Line 2: Year.</p> <p>Line 3: Hour:Minute.</p>	<p> Key pressed or held: No action.</p> <p> Key pressed or held: No action.</p> <p> Both keys pressed: No action.</p>
<p>8. Log Memory – Used</p>			<p>Displays the number of logs stored in the device's internal memory. Once the device's memory, which operates with circular memory, is full, the device will delete the oldest data to continue logging and will keep the number of logs close to the memory capacity.</p>	<p> Key pressed or held: No action.</p> <p> Key pressed or held: No action.</p> <p> Both keys pressed: No action.</p>
<p>9. Log Memory – Free</p>			<p>Displays the percentage of free memory. Once the device's memory, which operates with circular memory, is full and the percentage reaches 0%, the device will delete the oldest data to continue logging.</p>	<p> Key pressed or held: No action.</p> <p> Key pressed or held: No action.</p> <p> Both keys pressed: No action.</p>
<p>10. Log Memory – Pending Publication</p>			<p>Displays the number of logs pending publication in NOVUS Cloud.</p> <p>The number tends to be higher than 1 if the publication interval is longer than the interval between logs or if the data network is slow.</p> <p>If the free percentage is 0% and the number of logs pending publication is close to the number of logs used, this means that the device might be losing unpublished logs.</p>	<p> Key pressed or held: No action.</p> <p> Key pressed or held: No action.</p> <p> Both keys pressed: No action.</p>

SCREEN	MNEMONIC	INFORMATION	DESCRIPTION	
11. Device Information			<p>Displays device information. Line 1 and 2: Serial Number. Line 3: Firmware Version.</p> <ul style="list-style-type: none">  Key pressed or held: No action.  Key pressed or held: No action.   Both keys pressed: No action. 	
12. Mobile Network Connection Information			<p>Displays the status of the mobile network connection, informing how far the device was able to reach. The following messages may be displayed:</p> <p>First messages that may be shown:</p> <p>1.1 CELL OFF: The mobile network module is turned off. This may occur if the device is being powered solely via USB interface or if the following services are disabled: NOVUS Cloud, SMS, and GPS.</p> <p>1.2 CELL conn: The mobile network module is connecting. It may occur for a few instants when the device is starting up.</p> <p>1.3 CELL P In: SIM Card Error. It may occur in the event of SIM Card errors (loose contact, missing SIM Card, burned SIM Card or PIN error).</p> <p>1.4 CELL nEt: Network connection error. This may occur if the device is unable to get authenticated on a mobile network or in the following situations: weak signal, no operator network available in the region or access denied by the operator.</p> <p>Messages that may be displayed if only the NOVUS Cloud services are enabled:</p> <p>2.1 hEtP OFF: Failure in obtaining HTTP service. This may occur due to failure in the data plan, incorrect configuration of the APN/Login/Password, or error in the server Address/Port.</p> <p>2.2 hEtP conn: HTTP is connecting. It may occur for a few instants when connecting to the server (NOVUS Cloud).</p> <p>2.3 cLoU c IH: Error obtaining CIK from NOVUS Cloud. This may occur if the device's serial number has not been linked to an account on NOVUS Cloud or if the device has been configured to Clear CIK and the CIK has not been renewed in NOVUS Cloud.</p> <p>2.4 cLoU on: Connected to NOVUS Cloud. The connection was completed successfully.</p> <p>Messages that may be displayed if only the SMS services are enabled:</p> <p>3.1 SFS OFF: Failure starting the SMS service. It may occur for a few instants when the SMS service is starting up.</p> <p>3.2 SFS on: SMS is enabled. It only occurs if the SMS services are enabled and have been successfully started up. It is not possible to validate whether the operator is accepting sent and received SMS messages or if there is an SMS plan enabled.</p> <p>Messages that may be displayed if only the GPS service is enabled:</p> <p>4.1 GPS: The mobile network module is enabled. This only occurs if the SMS services and NOVUS Cloud are disabled, and the GPS service has been enabled.</p>	

SCREEN	MNEMONIC	INFORMATION	DESCRIPTION	KEY FUNCTIONS
<p>13. GPS Connection Information</p>			<p>Displays information about the device's GPS position.</p> <p>Line 1: Indicates the type of position obtained. "E5" indicates that an approximate position has been obtained; "2d" indicates that a position without altitude has been obtained and "3d" indicates that a position with altitude has been obtained.</p> <p>Line 2: Indicates whether GPS was able to obtain a valid position.</p> <p>FiH – It was possible to obtain a valid GPS position.</p> <p>no FiH – It was not possible to obtain a valid GPS position.</p> <p>Line 3: Indicates the horizontal dissolution value of the position (HDOP), which refers to the error estimate of the position obtained. The lower this value, the smaller the error possibility of the position obtained in relation to the actual position of the device.</p> <p>HDOP near 0: Error of meters.</p> <p>HDOP near 10: Error of kilometers.</p>	<p> Key pressed or held: No action.</p> <p> Key pressed or held: No action.</p> <p>  Both keys pressed: No action.</p>
<p>14. Display Contrast Adjustment</p>			<p>Displays the contrast level configured for the display and allows for adjusting the display.</p> <p>Line 3: Current contrast value. Can be adjusted from 0 to 7.</p>	<p> Key pressed or held: Increases contrast (maximum 7).</p> <p> Key pressed or held: Decreases contrast (minimum 0).</p> <p>  Both keys pressed: No action.</p>

SCREEN	MNEMONIC	INFORMATION	DESCRIPTION	KEY FUNCTIONS
15. Log Status			Displays the current log status and allows them to be started and/or paused if the device is configured to allow start and/or end By Keyboard. En – Logs enabled. d IS – Logs disabled.	Key pressed or held: Initiates logs if "By Keyboard" start mode is enabled. Key pressed or held: Pauses records if the "By Keyboard" end mode is enabled. Both keys pressed: No action.
16. Clear Alarm Status			Recognizes alarms and clears the status of those that already occurred so that they are no longer shown on the display or on the NXperience diagnostics screen.	Key pressed or held: No action. Key pressed or held: No action. Both keys pressed: Clears alarm status. Displays the "CLR" message upon completing the operation.
17. Digital Output Status			Displays current digital output status. En – Digital output engaged. d IS – Digital output disabled.	Key pressed or held: No action. Key pressed or held: No action. Both keys pressed: No action.
18. Turns off Device			Allows for shutting the device down while it is operating on internal backup power batteries. To turn it on again, it needs to be powered via USB interface or by an external power supply.	Key pressed or held: No action. Key pressed or held: No action. Both keys pressed: Turns off device.

Table 2 – Navigation keys

4. BACKUP BATTERIES (INTERNAL UPS)

LogBox 3G is a device that requires an external power supply to operate. Despite this, to ensure full operation in the event of power outages, the device features internal backup batteries that operate as an uninterruptible power supply. The internal batteries are charged automatically while the external power supply is present and will automatically take over as power supply during power outages.

Battery life depends on the interval between logging, the interval for publication to **NOVUS Cloud** and the number of batteries included in the device model. In cases where the interval between logs and the publication interval is 10 seconds (and considering that, in this example, batteries are 100 % charged), the typical battery duration is 2 hours for the model with 1 battery and 8 hours for the model with 4 batteries. For applications where the interval between logs and the publication interval is 1 minute, the typical duration is 6 hours for the model with 1 battery and 24 hours for the model with 4 batteries.

When running on backup batteries, the mobile network module will be automatically turned off by the device as soon as the battery reaches a level below 1%, thereby prolonging its duration and allowing the device to continue logging. For the mobile network module to resume operation, the device must be powered by an external power supply.

The device's internal batteries are Li-Ion and their chemistry may pose a risk of explosion if exposed to temperatures above or below the device operating temperatures (see [Technical Specifications](#) chapter). Moreover, they can only be charged in the specified temperature range (see [Technical Specifications](#) chapter). Thus, if the device is operating in an environment with temperature higher or lower than the range specified for the batteries, it will automatically stop charging the, which can lead to uncharged batteries during power outages.

In addition, a characteristic of these batteries is that they lose the charge capacity if they are recharged when the voltage falls below 2 V. To avoid this problem, the device will automatically shut down when the battery reaches levels below 3 V. Every battery, however, has a self-discharge current. In this way, it is important to consider the storage time with the device turned off. If the battery is stored for a long period of time, especially if it is partially discharged, it can be gradually discharged and reach a point where, when it is below 2 V, it is impossible to recharge it.

We recommend that you charge the battery up to at least 50 % before disconnecting the device for a long period of time, after which the procedure for manually disconnecting the device (see section [Navigation Screens](#)) is performed.

Replacing batteries can lead to risk of explosion. Hence, the cover for access thereto is factory sealed and they can only be replaced by the manufacturer or by authorized technical assistance.



Risk of explosion: Internal batteries may only be replaced by the manufacturer or authorized service provider.

Risk of explosion: Be careful with the device's operating temperature. Extremely high or low temperatures can cause ruptures and leaks in backup batteries and cause damage to the device.

5. INPUT SIGNAL READING

LogBox 3G allows users to choose, in addition to the channels to be recorded and the sensor types, some configurations that make various applications more flexible, offering the possibility of considering the energy resources expended (battery life) and data storage (log memory duration period). The device can thus be configured with the following parameters:

- **Logging Interval:** Frequency, in seconds, at which an acquisition must be made and saved in the memory. A low periodicity will increase battery consumption and fill up the memory faster.
 - **Minimum Interval:** 1 second
 - **Maximum Interval:** 12 hours

A registration interval of 300 seconds (5 minutes) or longer is recommended to preserve the cell phone data plan and the **NOVUS Cloud** storage. Below is the message that is displayed by the software if the **NOVUS Cloud** registration interval is less than 300 seconds.

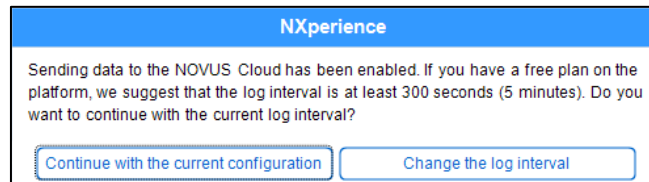

Figure 2 – NOVUS Cloud

- **Display Refresh Interval:** Frequency, in seconds, at which an acquisition must be made and refreshed on the display. It allows for saving memory by setting it to a longer logging interval, without impairing the display refresh rate. This interval can be configured to run in the same logging interval.
 - **Minimum Interval:** 1 second
 - **Maximum Interval:** 1 hour

When configuring a display refresh interval, it should be less than the logging interval. Otherwise, it will be ignored, and the display will be refreshed in the logging interval.

The display refresh interval only refreshes analog channels that are not configured to operate by mean. Thus, the digital channel that is configured to operate in count mode and the analog channels that are configured to operate by mean will only have their information refreshed at each logging interval.

If the digital channel is operating in "Event Logging" mode, it refreshes its respective display information at each event.

5.1 ANALOG INPUTS

LogBox 3G has two channels for reading analog signals. The types of signals and sensors accepted by them are:

- **Temperature Sensors:**
 - Thermoresistance Pt100
 - Thermocouples J, K, T, N, E, R, S and B
 - Internal Temperature Sensor
- **Linear Sensors:**
 - 0 to 50 mV
 - 0 to 5 V
 - 0 to 10 V
 - 0 to 20 mA
 - 4 to 20 mA
- **Internal Diagnostic Sensors:**
 - Battery Voltage
 - External Power Supply Voltage

Each type has specific operating configurations and characteristics. Its configurations and characteristics are described below:

- **Temperature Sensors:**
 - They inform the measured sensor temperature within the possible measurement range for each sensor;
 - The maximum resolution for the temperature sensors is 0.1 °C
 - They can be configured to be displayed with one or no decimal places
 - They can be configured to be displayed in °C or °F measurement units
- **Linear Sensors:**
 - Inform a magnitude in the range required by the user (defined under "User Range"), as configured in the "Lower Limit", "Upper Limit" and "Number of Decimal Places" parameters.
 - **Number of Decimal Places:** The use of 0, 1 or 2 decimal places can be selected.
 - **Lower Limit:** Corresponds to the value configured to represent the minimum value of the chosen sensor:
 - Minimum -19999 for 0 decimal places
 - Minimum -1999.9 for 1 decimal place
 - Minimum -199.99 for 2 decimal places

- **Upper Limit:** Corresponds to the value configured to represent the maximum value of the chosen sensor:
 - Maximum 19999 for 0 decimal places
 - Maximum 1999.9 for 1 decimal place
 - Maximum 199.99 for 2 decimal places
- They can be configured to be displayed in °C or °F measurement units, or in a custom unit of up to 8 characters, which will not be shown on the display.
- The maximum resolution for linear sensors corresponds to a ratio between the user range and the maximum resolution of the chosen sensor.
- **Internal Diagnostic Sensors:**
 - Inform the voltage from the possible **LogBox 3G** power supply sources
 - The maximum resolution for the internal diagnostic sensors is 0.01 V
 - They can be configured to be displayed with 0, 1 or 2 decimal places
 - The measurement unit for these sensors is Volts and no unit symbol is displayed

Refer to the [Technical Specifications](#) chapter to check the accuracy of these signals. Refer to the [Installation](#) chapter to check the connections for these signals.

An analog/digital (A/D) converter with high resolution and accuracy is used to read the sensors connected to the analog channel inputs. In the desired scan interval, all enabled analog channels will be read.

Each type of input signal has a valid measurement range (see [Technical Specifications](#) chapter). However, the device can typically measure signals that slightly exceed the limits of this range. How much it can measure beyond that, however, depends on the type of input configured and can vary between different devices.

The following table describes what to expect in the **LogBox 3G** display according to the signal applied to the input for each configured input type:

5.1.1 MEASUREMENT AND INDICATION OF INPUT TYPES

INPUT TYPE	INPUT SIGNAL CONDITION	INDICATION
Pt100	Within range	Read input value
	Pt100 with one or more wires disconnected	---- will be displayed -22000 will be logged in the memory
	Slightly above the upper limit	Read input value *
	Slightly below the lower limit	Read input value *
	Far above the upper limit	UUUU will be displayed 32767 will be logged in the memory
	Far below the lower limit	NNNN will be displayed -32000 will be logged in the memory
Thermocouples J, K, T, E, N, R, S and B	Within range	Read input value
	Open Thermocouple	---- will be displayed -22000 will be logged in the memory
	Slightly above the upper limit	Read input value *
	Slightly below the lower limit	Read input value *
	Far above the upper limit	UUUU will be displayed 32767 will be logged in the memory
	Far below the upper limit	NNNN will be displayed -32000 will be logged in the memory
Voltage 0 to 50 mV	Within range	Read input value converted into User
	Signal disconnected	---- will be displayed -22000 will be logged in the memory
	Slightly above the upper limit	Read input value converted into User Range *
	Slightly below the lower limit	Read input value converted into User Range *
	Far above the upper limit	UUUU will be displayed 32767 will be logged in the memory
	Far below the lower limit	NNNN will be displayed -32000 will be logged in the memory

Voltage 0 to 5 V 0 to 10 V	Within range	Read input value	
	Signal disconnected	0 V converted into User Range	
	Slightly above the upper limit	Read input value converted into User Range *	
	Slightly below the lower limit	Read input value converted into User Range *	
	Far above the upper limit	UUUU will be displayed 32767 will be logged in the memory	
	Far below the lower limit	NNNN will be displayed -32000 will be logged in the memory	
Current 0 to 20 mA 4 to 20 mA	Within range	Read input value converted into User Range	
	Signal disconnected	0 a 20 mA	0 mA converted into User Range
		4 a 20 mA	---- will be displayed -22000 will be logged in the memory
	Slightly above the upper limit	Read input value converted into User Range *	
	Slightly below the lower limit	0 a 20 mA	It is not possible to decrease more than the lower limit
		4 a 20 mA	Read input value converted into User Range *
	Far above the upper limit	UUUU will be displayed 32767 will be logged in the memory	
	Far below the lower limit	0 a 20 mA	It is not possible to decrease more than the lower limit
		4 a 20 mA	NNNN will be displayed -32000 will be logged in the memory

(*) **Note:** The analog channel indication continues slightly beyond the limits specified for the selected input type. However, in this condition, accuracy is not guaranteed.

Table 3 – Measurement and indication of input types by LogBox 3G

LogBox 3G allows for configuring settings to be applied to analog sensor readings. These settings can be used to correct errors in the sensor or process in which the sensor is installed and are applied individually for each analog channel. Two adjustment modes are provided:

- **Offset:** Allows each analog channel to select an Offset value to be added to the channel reading indication. It is a simple and fast feature for adjusting the indication in the whole range.
- **Custom Calibration:** Allows for entering up to 10 Setpoints for each channel to correct distortions in reading these channels at these points. We call this characteristic a "Custom Calibration" because it allows the user to adjust the indication at the desired points, resetting the error. The adjustment is made linearly between the entered points, according to the values entered.

It warrants emphasis that both setting the offset and entering custom calibration points are optional, only indicated for those who wish to adjust the indication to a local standard, because the **LogBox 3G** already comes pre-calibrated from the factory.

	Whenever changing the input type, make sure the custom calibration points for the previous input are deleted!
---	--

For each analog channel, a unique name (tag) must be assigned, which will be used to reference the channel. The type of input (sensor) that will be connected to that channel must also be selected. Additionally, the measured unit value can be assigned: for temperature sensors (Pt100 or thermocouples), the Celsius (°C) or Fahrenheit (°F) degree unit can be selected; for linear sensors (current or voltage), the desired unit can be typed in.

In the case of linear input types, the sensor indication range must be defined, determining what the channel should indicate when the input is at its minimum value and what it should indicate when at its maximum value (minimum and maximum values considering the **LogBox 3G** working range for the chosen input type). Once the input type 4 to 20 mA is selected, for example, a 0 to 2-bar pressure transmitter will be connected. In this case, "0.0" should be chosen as minimum value and "2.0" as maximum value in the input configuration. All available resolution and accuracy will be contained within the chosen range.

When a device that is connected to the mains (a thermocouple or voltage simulator, for example) is used at the analog inputs and is not isolated, using a reading interface other than USB is recommended. In some cases, noise and read offsets have already been detected due to the influence of the USB cable connection, probably due to ground loops.

Configuring the local grid frequency (50 Hz or 60 Hz) is important because it helps improve the performance of analog channel reading. Usually, the power grid causes interference in the signal read by the sensors, which can be more easily mitigated if we know the frequency.

5.2 DIGITAL INPUT

LogBox 3G has a digital input channel that can be configured for "Pulse Count", "Event Logging" or even "Log Control" modes. The digital input can be disabled.

Regardless of the function for which it will be used, the type of sensor that will be connected to the input must be configured: PNP, NPN or Dry Contact (see [Installation](#) chapter to see how the sensors should be connected). Moreover, the edge of interest for the digital signal needs to be selected to generate the count, event, or logging start/end: rising edge, falling edge or both edges.

RELATIONSHIP BETWEEN SENSOR TYPE, SENSOR STATUS AND LOGICAL LEVEL OBTAINED IN LOGBOX 3G		
Sensor Type	Sensor Status	Logical Level
PNP	Open	0
	Closed	1
NPN	Open	1
	Closed	0
Dry Contact	Open	1
	Closed	0

Table 4 – Digital Input

For Dry Contact sensors, a debounce time of at least 50 ms needs to be configured (sensor stabilization time/time during which the sensor should remain in the appropriate status for it to be considered valid). Debounce time does not need to be configured for PNP or NPN sensors in "Pulse Count" mode. However, if the digital input is configured for the "Event Logging" or "Log Control" modes, a minimum debounce of 50 ms is required to keep any noise from generating a false event. In the "Event Logging" and "Log Control" modes, events will be generated after the end of the debounce time.

5.2.1 PULSE COUNT

When setting the digital input in "Pulse Count" mode, you can select an application mode: "Flow Rate" or "Count".

The "Flow Rate" mode allows, if "Average Flow by Acquisition Interval" is selected, to log the average flow rate or, if "Volume Since Last Reset" is selected, to count the total volume within a previously configured period until the count is reset.

The "Count" mode, in turn, allows, if the "Acquisition Interval Counting" option is selected, to count the number of pulses that occurred within the Log Interval or, if the "Accumulated Count Since Last Reset", to count the total number of pulses logged within a preset period until the count is reset.

LogBox 3G has a 32-bit register, responsible for accumulating the volume or number of pulses within a certain configurable reset interval. For example, you can set the device to reset on a monthly basis or on a specific day and time (see the [Accumulator Resetting](#) section of the [Configuration Software](#) chapter).

LogBox 3G also has a 16-bit register, responsible for measuring the average flow rate per acquisition interval or for performing the count per acquisition interval. At each logging interval, **LogBox 3G** counts the number of pulses that have occurred and registers it in memory, resetting the register so that it can accumulate the pulses of the next interval.

If the sensor is a Dry Contact type, the **LogBox 3G** count registers (16 bits and 32 bits) will be able to count up to 10 pulses per second. For PNP and NPN sensors, 2000 pulses per second. However, in the case of the 16-bit register, it is important to note that these pulses will accumulate within each logging interval. Thus, if the "Average Flow Through Acquisition Interval" or "Acquisition Interval Count" modes are selected, it is necessary to evaluate the maximum sensor frequency so that it does not exceed 65535 counts (16 bits) within the logging interval, causing an overflow in the logger that accumulates them.

If the maximum sensor frequency is 2 kHz, **LogBox 3G** will accumulate 2000 pulses per second for up to 32 seconds. Upon exceeding this interval, the number of accumulated pulses will exceed 65535 counts, resulting in overflow in the 16-bit register. For a sensor that can reach 2000 pulses per second, the recommended log frequency should be less than 32 seconds.

When the option "Volume since last reset" or the option "Accumulated count since last reset" is selected, the number of counts is, in turn, limited by the 32-bit accumulator register and, thus, enables the counting of a limit number of 4294967295 pulses. Thus, the periodicity of the reset must also be adjusted according to the frequency of the sensor pulses. By keeping the same example of sensor use at maximum frequency, i.e. 2 kHz, it is recommended that the periodicity be less than 24 days, otherwise an overflow will be generated in the register.

In typical applications, such as flow and volume measurement, simple pulse counting is not enough, and these pulses need to be converted into a flow unit. To do so, the desired flow unit and a conversion factor can be selected to transform the number of pulses generated by the connected transmitter into flow information. Pulses logged in the interval will be converted to the user-configured flow unit every time the logged data is displayed.

To facilitate configuration of the digital channel in "Pulse Count" mode and conversion to the flow unit required, **LogBox 3G** provides the following measurement units:

FLOW UNITS	SENSOR UNITS
l/s,	pulses/l, pulses/gal, pulses/m ³ .
l/min,	
l/h,	
gal/s,	
gal/min,	
gal/h,	
m ³ /s,	
m ³ /min,	
m ³ /h.	

Table 5 – Measurement units

If the user uses any of the flow and sensor units, the "Sensor Factor" will need to be informed. If none of the available units are required, the "Unit Factor" needs to be calculated by relating the "Unit" parameter and filling it in so that the device correctly converts pulses to the required unit. In this case, **LogBox 3G** will convert the pulses to the user-defined unit as follows:

- User Value = ((Count)/(Sensor Factor))*(Unit Factor)
 - It is not necessary to consider the records interval for calculations.

Figure 3 – Digital Input Screen

If the user wants to view the production of parts in "parts per minute", for example, and the application has a PNP type sensor that calculates one part produced for every 30 rising edge pulses, the following parameters must be configured at the device's digital input:

- **Input Type:** Pulse Count.
- **Sensor Type:** PNP.
- **Counting Edge:** Rise.
- **Application:** Flow Rate.
- **Sensor Factor:** 30 (pulses/part).

It is necessary to select the **Average Flow by Acquisition Interval** option and fill in the following parameters:

- **Unit:** Customized.
- **Unit Factor:** 60 (conversion from parts per second to parts per minute).

It is also possible to select the **Volume Since Last Reset** option and fill in the following parameters:

- **Unit:** Customized.
- **Sensor Factor:** 1 (stores the cumulative number of parts).

LogBox 3G will thus record the number of pulses occurring within that period at each logging interval, and every time the data is displayed, it will transform the pulses into the number of parts produced per minute (user-customized unit).

In the same example, the logging interval can be assumed to be 20 seconds. As such, if the sensor gives 20 pulses per second, **LogBox 3G** will record 400 pulses per interval, displaying 40 parts per minute $((20 \text{ pulses/s}) / (30 \text{ pulses/part}) * 60 (1 \text{ min}) = 40)$.

5.2.2 EVENT LOG

If the digital input is configured in "Event Logging" mode, each selected edge will create a record in the memory, reporting the event and the instant that it occurred. This log will not be synchronized with the periodic logs but will respect the start and end log modes. Events will be logged after the configured debounce time expires. Events will be thus logged with the debounce time delay. **LogBox 3G** can log up to 10 events in 10 seconds.

In addition to logging aperiodic events, **LogBox 3G** can also be configured to periodically record the digital input value. As such, in the logging interval, the device will record whether the digital input is at logical level '1' or at logical level '0'. This is useful for providing graphic monitoring of the digital input status along with the analog channels.

In **NOVUS Cloud**, **LogBox 3G** will publish aperiodic events in a table containing the event timestamp and the logical level at the time of the event. The publication of all events recorded in the memory can thus be ensured. However, these events cannot be shown in graphic format via **NOVUS Cloud**. To do so, the device needs to be configured to log the status of the digital input periodically, along with the analog channels. As such, the status of the digital input can be monitored graphically at the logging frequency.

5.2.3 LOG CONTROL

The digital input can be used to start and/or pause the logs from the other input channels. Once configured in "Log Control" mode, each selected edge will start or stop the logging in memory process. As in the "Event Logging" mode, there will only be action related to detected events after the configured debounce time expires. As such, logs will be started/paused with the debounce time delay.

6. DIGITAL OUTPUT

LogBox 3G has an NPN type digital output that, when enabled, sets the external power supply GND terminal to the digital output pin.

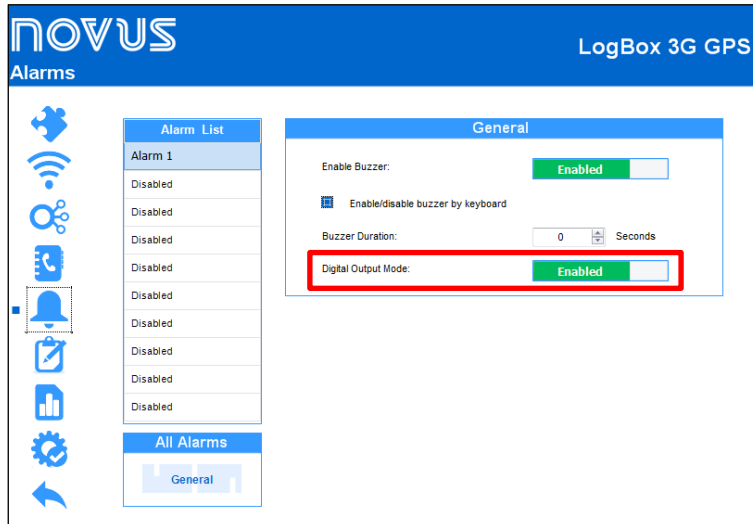

Figure 4 – Digital Output Screen

The digital output in LogBox 3G can be disabled or configured to monitor the status of alarms linked to the digital output. Each alarm can be configured to trigger the digital output independently.

For each configured alarm, it can be configured independently to trigger the digital output. If more than one alarm is configured to trigger the digital output, it will only be disabled when no alarm condition is met.

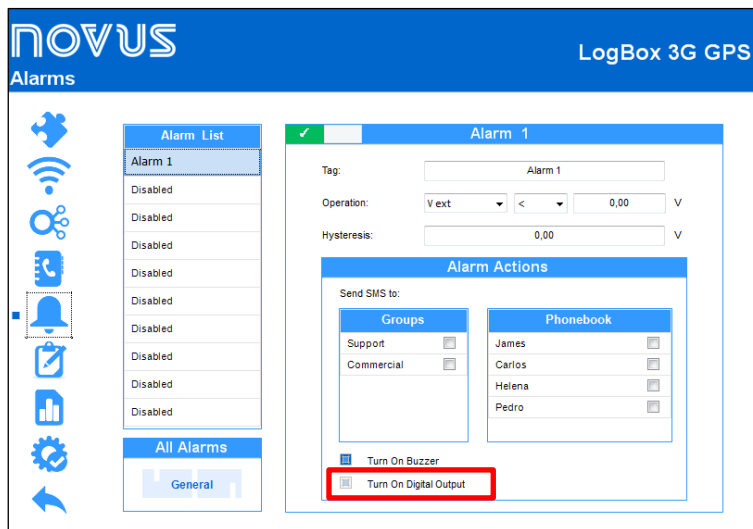

Figure 5 – Alarm actions

In addition to linking alarms to trigger the digital output, the digital output can also be configured to be triggered via SMS commands (see [SMS](#) chapter).

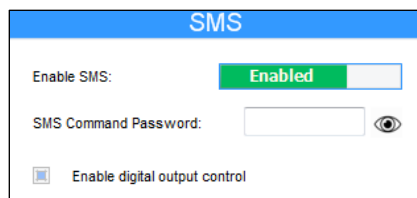

Figure 6 – SMS actions

7. DATA LOGGING

Data will be recorded in the **LogBox 3G** internal memory. The internal memory capacity is up to 140,000 logs. The device uses its internal memory as a backup location for data that have not yet been published to **NOVUS Cloud**. As such, if the communication link is lost, the data will remain secure in the device's memory until the link can be restored.

The memory operates circularly, so that once it is full, it automatically deletes the oldest data to make room for newer data. This process also allows for downloading up to 140,000 logs via the USB interface. The number of logs that can be stored in the internal memory basically depends on the number of input channels that are enabled, as well as factors such as recording or not recording digital input events.

The table below illustrates the memory capacity when the device is configured to record 1 or 8 channels.

NUMBER OF CHANNELS AND MAXIMUM LOG CAPACITY			
Number of Channels Enabled	Maximum Log Capacity	Memory Duration with 10 Seconds Interval	Memory Duration with 15-Minute Interval
1	More than 140,000 logs from 1 channel	More than 16 days of backup	More than 4 years of backup
...
8	More than 35,000 logs from 8 channels	More than 4 days of backup	More than 1 year of backup

Table 6 – Data Logging

Any channel types (analog and digital in the "Pulse Count" or "Event Logging" modes), internal sensors (battery level, external power supply voltage or internal temperature) or GPS coordinate can be logged in the memory. Except for the digital channel in "Event Logging" mode, logging will be periodic and will have an interval configured via configuration software. At the end of each logging interval, the current values of channels enabled and configured to be recorded will be logged in the memory.

If the digital input is configured in "Event Logging" mode, the events it detects will be logged asynchronously to the periodicity of other channels, at the moment the event occurs. If the option to log the digital input synchronously is also selected, the device will also log the logical level of the digital input at each logging interval.

LogBox 3G allows data configured to be logged in the memory to be published to **NOVUS Cloud**. For this purpose, information published to **NOVUS Cloud** must have been logged in the memory.

The device can be configured so that some information is logged exclusively in memory and not published to **NOVUS Cloud** or for the device not to publish any logs to **NOVUS Cloud**. These options allow **LogBox 3G** to operate with higher log capacity, less data traffic, and in some cases, even with no data plan, if the user does not want more than one data logger to send SMS events.

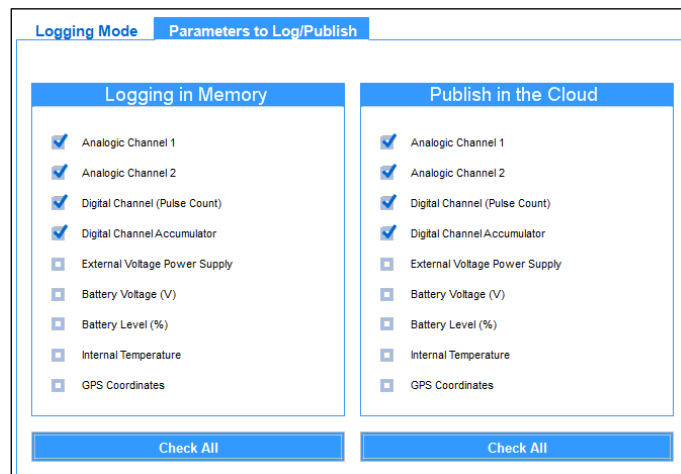

Figure 7 – Selecting Parameters

There are several ways to start and stop logging. Many of them can be freely combined. During logging, the selected channels will be logged in the memory and the interval between logs will be respected.

Depending on the type of start and end selected, there may be log snippets in the memory and periods with no logged data as a result. This is fully compatible with the device and does not pose any problem.

The device features the following start modes:

- **Immediate Start:** Allows logging to be started shortly after the device is reconfigured.
- **By Date/Time:** Allows logging to be started at the configured date/time.
- **By Keyboard:** Allows for changing the status of logs to enabled on a display screen, starting logs if they have not yet been started.

- **By Digital Input:** Allows logging to be started from the digital input. For this option to be available, the digital input channel must have been set to "Log Control" mode. There are four modes for controlling logs through the digital input:
 - Start logs at each rising edge
 - Start logs at each falling edge
 - Log at logical level '1', which logs while at logical level '1'
 - In this mode, the configured end mode should be "Pauses at logical level '0'".
 - Record at logical level '0', which records logs while at logical level '0'
 - In this mode, the configured end mode should be "Pauses at logical level '1'".
- **Daily:** Allows logging to be started every day and at the configured time. A "Daily" log start mode requires a "Daily" log end mode.
- **By Software:** Allows logging to be started by means of a command from **NXperience** or **NOVUS Cloud**.
- **By Software:** Allows logging to be started via an SMS command.

The device features the following end modes:

- **Non-Stop:** Allows logging to continue indefinitely.
- **By Date/Time:** Allows logging to be concluded at the configured date/time.
- **By Keyboard:** Allows for changing the status of logs to disabled on a display screen, pausing logs if they have not yet been paused.
- **By Digital Input:** Allows logging to be concluded from the digital input. For this option to be available, the digital input channel must have been set to "Log Control" mode. There are four modes for controlling logs through the digital input:
 - Pause logs at each rising edge
 - Pause logs at each falling edge
 - Pause at logical level '0', which pauses while at logical level '0'
 - In this mode, the configured start mode should be "Records at logical level '1'".
 - Pause at logical level '1', which pauses while at logical level '1'
 - In this mode, the configured start mode should be "Records at logical level '0'".
- **Daily:** Allows logging to be paused every day and at the configured time. A "Daily" log end mode requires a "Daily" log start mode.
- **By Software:** Allows logging to be paused by means of a command from **NXperience** or **NOVUS Cloud**.
- **By Software:** Allows logging to be paused via an SMS command.

8. ALARMS

LogBox 3G allows for registering up to 10 alarms, where any measured magnitude (registered or not) can be compared to a value and linked to an action when the comparison is met. The alarms are shown on the display and can be configured individually to trigger an internal buzzer for audible warning, to trigger a digital output for user control, or to send an SMS as notification to one or more contacts.

When an alarm condition is met, the **ALM** symbol will light up along with the **1**, **2**, **3**, **4** symbols, corresponding to the channels that meet the current alarm status. The **1** and **2** symbols correspond, respectively, to the alarms linked to analog channels 1 and 2. The symbol **3** corresponds to alarms linked to internal channels (internal temperature, battery voltage or external power supply voltage). The symbol **4** corresponds to alarms linked to the digital channel. The **ALM** symbol indicates that, since the device was powered on or since the last alarm status was cleared, an alarm occurred. The retentive alarm statuses of each channel can be cleared through the display screens or through **NXperience**.

The Tag (alarm ID used in the SMS text), the hysteresis (value to be exceeded for the channel to exit the alarm situation) and a comparison symbol (<, >, <=, >=, =, !=) need to be configured with a setpoint (value to be exceeded for the channel to meet the alarm condition) for each configured alarm. Buzzer triggering, digital output triggering and contacts for sending SMS messages can also be linked to each configured alarm.

The buzzer has a series of general configurations that allow for enabling/disabling it, muting it By Keyboard and configuring its duration for each time an alarm situation is met. The buzzer will be turned off when all alarms that triggered the linked buzzer are not met. The alarm status information, as well as the maximum and minimum values reached in each channel, will be refreshed by any events that trigger an acquisition, which may be readings during the logging interval or the display refresh interval. If a channel reaches a minimum or maximum value or an alarm condition during an acquisition other than the logging interval, it may not be logged in the memory. As such, statuses may indicate that the channel has already reached one of these situations and that the information is not available in a download.

On the [Contacts](#) screen in **NXperience** software, a contact list can be created, from which groups can be created which will later be authorized to receive SMS messages with alarm warnings whenever an alarm situation is met. Each SMS can have up to 150 characters. Refer to the [SMS](#) chapter for more detailed information about each SMS.

9. DEVICE DATE/TIME

The device will only record logs if the date/time has been configured.

If date/time syncing is disabled, the device will use the user-configured date/time, not correcting it until a new configuration is applied. Hence, if the device is shut down during a power outage, it will not log data to the memory or publish data to **NOVUS Cloud** until a new configuration is received.

If date/time is enabled, the device will synchronize the date/time automatically with **NOVUS Cloud** or with the GPS interface, if enabled, which has higher priority.

If automatic syncing is enabled, the device will automatically resume data logging and publication after power returns. If automatic syncing is disabled, the device will not resume data logging and publication after power returns, with both actions suspended until a new configuration is entered.

10. COMMUNICATING WITH NOVUS CLOUD

LogBox 3G requires a SIM Card with active data plan for correct operation with **NOVUS Cloud** (<https://iot2.novusautomation.com/>), a cloud portal that allows for managing logged data and setting remote configurations in the device. Once the user has created an account in **NOVUS Cloud** and then linked the device to it, **LogBox 3G** will start communicating with the cloud, placing published data on exclusive dashboards for the device.

In addition to viewing via **NOVUS Cloud**, data can also be managed that are published via **NXperience**, software that offers a complete user experience, allowing for local and remote configuration of the device and management of published data. Apart from the graphic analysis, it also allows for generating reports and exporting in various formats.

In general, each **LogBox 3G** has access to a free¹ account that will not be charged a monthly fee for use of **NOVUS Cloud** resources and which allows the user to register as many devices in as many accounts as desired. Each device, however, can only be registered in a single account.

The first registration or authentication of a previously registered user can be performed via **NXperience**. After authenticating the user and once the device is connected to the USB interface, **LogBox 3G** will be linked to the corresponding account and recognized by its serial number. An Internet connection is required for this procedure.

If communication with **NOVUS Cloud** is running successfully, the wireless symbol will remain on. If the wireless symbol is off or flashing, see [Display and Navigation](#) chapter to identify the problem.

In addition to registering new devices, **NXperience** allows for remote configuration and data collection from the device via **NOVUS Cloud**. Configuration via **NOVUS Cloud** is not instantaneous, considering that, if turned on, with data communication over the mobile network and authenticating with **NOVUS Cloud**, the device will look for configurations as configured in the "Configuration Update Interval" parameter.

The data download process will search all data published on **NOVUS Cloud**.

¹ Each account in **NOVUS Cloud** has a storage limit. Check the **NOVUS Cloud** manual, available on our website, for the storage capacity and for how many years it will be kept.

11. SMS

LogBox 3G has the SMS feature, which allows for informing the user about different device situations. Event SMS messages are automatic warnings about channels in alarm condition; Command SMS messages, in turn, have various functions, which range from setting device configurations to checking specific information.

For SMS features to function properly, a SIM Card with enabled SMS plan is required.

11.1 EVENTS

Events correspond to alarm situation replies via SMS to contacts or groups previously registered on the "[Contacts](#)" screen and selected on the "[Alarms](#)" screen of **NXperience** (see [Configuration Software](#) chapter).

The text below illustrates a sample SMS sent by the device:



Figure 8 – SMS Example

The table below illustrates the four parameters that make up an Alarm Event SMS, disregarding spaces between them (which are considered command separators):

	PARAMETER	EXAMPLE
1st Parameter	Hour:min:second at which the event was processed	10:54:47
2nd Parameter	Date on which the event was processed	3/1/2018
3rd Parameter	Device tag	"LogBox 3G"
4th Parameter	Alarm tag	"Alarm-01"

Table 7 – Event SMS Parameters

11.2 COMMANDS

Commands correspond to actions that **LogBox 3G** can take via SMS messages generated by the user to the device. By means of SMS commands, **LogBox 3G** allows for performing some operations remotely. With these commands, some device statuses can be requested (Read), some operating parameters can be edited (Write), and the device can be asked to take some actions (Write).

To restrict access to SMS command functions, a password needs to be configured.

To use SMS functions and commands, a SIM Card with enabled SMS plan is required.

Each message is divided into different operators with different functions, required for the device to properly understand the action requested by the user. Moreover, multiple commands can be sent in a single message, abiding by the maximum length of 150 characters.

Following is a description of all symbols and commands used in the available SMS commands.

11.2.1 SYMBOLS

SYMBOL DESCRIPTION	SYMBOL
Start of Message	<
End of Message	>
Command Separator	Blank space
Password Validation Operator	#
Write Operator	=
Read Operator	?

Table 8 – Meaning of each symbol for command SMS

As shown in **Table 08**, operators are used for sending specific commands to the device or receiving specific information from the device. Write operators send commands to define and change values, for example. Read operators return information about pre-configured parameters.

The password validation operator is used to authenticate the registered password. If there is no password previously registered in the device, the password validation operator should be entered with the password blank (pass#). If there is a password registered, it should be entered right after the (pass#1234), with no spaces.

11.2.2 COMMAND LIST

The SMS function has different commands, shown on the following table:

COMMAND	PARAMETER	FUNCTION
gprsapn	GPRS - APN	Editing or reading the mobile network operator's GPRS APN parameter (see Mobile Network Interface section).
gprslogin	GPRS - Login	Editing or reading the mobile network operator's GPRS Login parameter (see Mobile Network Interface section).
gprspass	GPRS - Pass	Editing or reading the mobile network operator's GPRS Pass parameter (see Mobile Network Interface section).
pass	Password	Allows for changing the password for SMS commands.
output	Digital Output	Change or obtain information about the status of the digital output.
alm1sp	Alarm 1 - "Setpoint"	Change or read Setpoint for alarm 1.
alm2sp	Alarm 2 - "Setpoint"	Change or read Setpoint for alarm 2.
alm3sp	Alarm 3 - "Setpoint"	Change or read Setpoint for alarm 3.
alm4sp	Alarm 4 - "Setpoint"	Change or read Setpoint for alarm 4.
alm5sp	Alarm 5 - "Setpoint"	Change or read Setpoint for alarm 5.
alm6sp	Alarm 6 - "Setpoint"	Change or read Setpoint for alarm 6.
alm7sp	Alarm 7 - "Setpoint"	Change or read Setpoint for alarm 7.
alm8sp	Alarm 8 - "Setpoint"	Change or read Setpoint for alarm 8.
alm9sp	Alarm 9 - "Setpoint"	Change or read Setpoint for alarm 9.
alm10sp	Alarm 10 - "Setpoint"	Change or read Setpoint for alarm 10.
log	Record Log	Enable or obtain information about the record log.
stsdev	Device Status	Obtain information about the device status.
stsconn	Mobile Network Connection Status	Obtain information about the mobile network status.
stsgps	GPS Status	Obtain information about the GPS status.
stsachs	Analog Channels Status	Obtain information about the analog channels status.
stdchs	Digital Channels Status	Obtain information about the digital channels status.
stsalms	Alarms Status	Obtain information about the alarm status.

Table 9 – Command list

The commands should be used along with the message start and end symbols and the respective operators (for password validation, execution and reading), as shown in the examples below.

If a device is configured to run commands via SMS, has its password set as "1234", its "gprspass" as "vivo" and the user wants to change the "gprslogin" to "vivo" and check the value of the "gprspass" parameter, the following message must be sent to the number of the SIM Card registered in the device:

<pass#1234 gprslogin=vivo gprspass?>

In this case, as shown in the table below, an SMS was sent with three commands: authentication, write and read.

Symbol	Meaning	Function
<	Message initializer	Mark the beginning of a message.
pass#1234	1st Command: Password Validation Command	Conduct a password test and, if approved, connect to the device.
gprslogin=vivo	2nd Command: Write Command	Request that the device change the gprslogin to "vivo".
gprspass?	3rd Command: Read Command	Request a reply regarding the gprspass configured for the device.
>	Message finalizer	Mark the end of a message.

* Blank spaces between commands are considered command separators.

Table 10 – Example of command sent to the device

As a result, its reply, as shown in the following SMS, will provide relevant device information:

<20:35:14 29/01/17 "LogBox 3G" gprslogin=vivo gprspass?vivo>

Symbol	Meaning	Function
<	Message initializer	Mark the beginning of a message.
20:35:14	Time at which the message was processed	Inform the time at which the message was processed
1/29/17	Date on which the message was processed	Inform the date on which the message was processed
"LogBox 3G"	Device tag	Enter the tag defined for the device.
gprslogin=vivo	2nd Command: Response to Write Command	Confirm the success of the requested change.
gprspass?vivo	3rd Command: Response to Read Command	Answer the question in the previous SMS.

>	Message finalizer	Mark the end of a message.
---	-------------------	----------------------------

* Blank spaces between commands are considered command separators.

Table 11 – Example of response to command sent to the device

	The pass command (accompanied by the password) must be informed in any SMS sent to the device. If the device does not have a password, the command will still need to be sent, but the password parameter should be left blank.
---	--

11.3 ERROR AND SUCCESS MESSAGES

With success, the SMS sent by the device will confirm the parameters sent by the user, as shown in the table below:

"OK" Message	
Command	<pass#1234 gprslogin=vivo gprspass=vivo gprsapn=zap.vivo.com.br>
Response	<20:35:14 29/01/17 "LogBox 3G" gprslogin=vivo gprspass=vivo gprsapn=zap.vivo.com.br>

Table 12 – Sample "OK" Message

If the previously entered password does not match the registered password, the SMS sent by the device will include a password error warning:

"Error Password" Message	
Command	<pass#123 gprslogin=vivo gprspass=vivo gprsapn=zap.vivo.com.br>
Response	<20:35:14 29/01/17 "LogBox 3G" "Senha Incorreta! / Wrong Password!">

Table 13 – Sample "Password Error" Message

If the informed command is not recognized by the device, the SMS sent by the device will include a command error:

"Error Command" Message	
Command	<pass#1234 gprslogi=vivo gprspass=vivo gprsapn=zap.vivo.com.br>
Response	<20:35:14 29/01/17 "LogBox 3G" "error" gprspass=vivo gprsapn=zap.vivo.com.br>

Table 14 – Sample "Command Error" Message

If the SMS sent by the user contains an operator not recognized by the device, the SMS sent by the device will inform an operation error:

"Error Operating" Message	
Command	<pass#1234 gprslogin=vivo gprspass&vivo gprsapn=zap.vivo.com.br>
Response	<20:35:14 29/01/17 "LogBox 3G" gprsuser=vivo gprspass"error" gprsapn=zap.vivo.com.br>

Table 15 – Sample "Operating Error" Message

11.4 OTHER EXAMPLES

Following are some examples of commands and their replies in different situations. Some commands have multiple functions. Others, however, have only one.

GPRS – APN		
Command used for obtaining and changing the "GPRS – APN" value.		
	Example 1 (Read)	Example 2 (Write)
Command	<pass#1234 gprsapn?>	<pass#1234 gprsapn=zap.vivo.com.br>
Response	<12:54:27 13/11/2017 "LogBox 3G" gprsapn?zap.vivo.com.br>	<12:54:27 13/11/2017 "LogBox 3G" gprsapn=zap.vivo.com.br>

Table 16 – Sample Message: GPRS – APN

GPRS – Login		
Command used for obtaining and changing the "GPRS – Login" value.		
	Example 1 (Read)	Example 2 (Write)
Command	<pass#1234 gprslogin?>	<pass#1234 gprslogin=vivo>
Response	<12:54:27 13/11/2017 "LogBox 3G" gprslogin?vivo>	<12:54:27 13/11/2017 "LogBox 3G" gprslogin=vivo>

Table 17 – Sample Message: GPRS - Login

GPRS – Password		
Command used for obtaining and changing the "GPRS – Password" value.		
	Example 2 (Read)	Example 3 (Write)
Command	<pass#1234 gprspass?>	<pass#1234 gprspass=vivo>
Response	<12:54:27 13/11/2017 "LogBox 3G">	<12:54:27 13/11/2017 "LogBox 3G" gprspass=vivo>

	gprspass?vivo>	
--	----------------	--

Table 18 – Sample Message: GPRS – Password

Password			
Command used to limit access to SMS commands.			
	Example 1 (Execution)	Example 2 (Read)	Example 3 (Write)
Command	<pass#1234>	<pass#1234 pass?>	<pass#1234 pass=4321>
Response	<12:54:27 13/11/2017 "LogBox 3G">	<12:54:27 13/11/2017 "LogBox 3G" pass?1234>	<12:54:27 13/11/2017 "LogBox 3G" pass=4321>

Table 19 – Sample Message: Password

Digital Output		
Command used for obtaining and changing the status of the digital output.		
	Example 2 (Read)	Example 3 (Write)
Command	<pass#1234 output?>	<pass#1234 output=1>
Response	<12:54:27 13/11/2017 "LogBox 3G" output?0>	<12:54:27 13/11/2017 "LogBox 3G" output=1>

Table 20 – Sample Message: Digital Output

Alarms – Setpoint		
Command used for obtaining and changing the Setpoint of alarms.		
	Example 2 (Read)	Example 3 (Write)
Command	<pass#1234 alm1sp?>	<pass#1234 alm1sp=230>
Response	<12:54:27 13/11/2017 "LogBox 3G" alm1sp?-1.25>	<12:54:27 13/11/2017 "LogBox 3G" alm1sp=230>

Table 21 – Sample Message: Alarm Configurations

Record Log		
Command used for obtaining and changing the record log status.		
	Example 2 (Read)	Example 3 (Write)
Command	<pass#1234 log?>	<pass#1234 log=1>
Response	<12:54:27 13/11/2017 "LogBox 3G" log?0>	<12:54:27 13/11/2017 "LogBox 3G" log=1>

Table 22 – Sample Message: Record Log

Device Status		
Command used to obtain the current device status. Returns information about power supply, external power supply voltage, battery percentage, Cold Joint temperature and reset counter.		
	Example 2 (Read)	Example 3 (Write)
Command	<pass#1234 stsdev?>	∅
Response	<12:54:27 13/11/2017 "LogBox 3G" stsdev?Ext,14.13V,100.00%,28.4oC,41>	∅

Table 23 – Sample Message: Device Status

Device Status		
Command used to obtain the status of the connection to NOVUS Cloud.		
	Example 2 (Read)	Example 3 (Write)
Command	<pass#1234 stsconn?>	∅
Response	<12:54:27 13/11/2017 "LogBox 3G" stsconn?Cloud_On>	∅

Table 24 – Sample Message: Connection Status

Status of Analog Channels		
Command used to obtain the status of the device analog channels. Returns information about the Channel 1 value and about the Channel 2 value.		
	Example 2 (Read)	Example 3 (Write)
Command	<pass#1234 stsachs?>	∅
Response	<12:54:27 13/11/2017 "LogBox 3G" stsachs?Ch1_ "Univ.Channel->	∅

	1"_25.3oC,Ch2_"Univ.Channel-2"_27.2oC>	
--	--	--

Table 25 – Sample Message: Analog Channels Status

Digital Channel Status		
Command used to obtain the devices current digital channel status. If set to "Event Logging" or "Log Control", it returns the status that generated the last event and its date and time. If set to "Counter" mode, it returns the counter value.		
	Example 2 (Read)	Example 3 (Write)
Command	<pass#1234 stsdchs?>	∅
Response	"Event Logging": <12:54:27 13/11/2017 "LogBox 3G" stsachs?Ch_"Digital.Channel"_Event_In-0_09:34:21_13/11/2017> "Contador": <12:54:27 13/11/2017 "LogBox 3G" stsachs?Ch_"Digital.Channel"_Count_23.61>	∅

Table 26 – Sample Message: Digital Channel Status

Alarm Status		
Command used to obtain the status of device alarms. Informs whether the alarm is enabled or disabled, and if enabled, its status.		
	Example 2 (Read)	Example 3 (Write)
Command	<pass#1234 stsalms?>	∅
Response	<12:54:27 13/11/2017 "LogBox 3G" stsalms?Alm1_On,Alm2_Off,Alm3_Dis,Alm4_Dis,Alm5_Dis,Alm6_Dis,Alm7_Dis,Alm8_Dis,Alm9_Dis,Alm10_Dis,>	∅

Table 27 – Sample Message: Alarms Status

Accumulator Resetting		
Command used for accumulator resetting.		
	Example 2 (Read)	Example 3 (Write)
Command	∅	<pass#1234 clrdchacc#>
Response	∅	<15:17:45 15/03/2019 "LogBox-3G" clrdchacc#"

Table 28 – Sample Message: Accumulator Resetting

12. GPS

LogBox 3G has a GPS interface, only available in the version with GPS device, which should be enabled via configuration software (see [Configuration Software](#) chapter).

The GPS antenna, which comes with the device, should be positioned in an unrestricted area that can be easily seen by satellites (see [Installation](#) chapter to see the external antenna positioning and fitting the antenna to the device). Its correct positioning ensures proper operation of the device's GPS.

If enabled in the configuration software and configured to be logged and published to **NOVUS Cloud**, the position of the device will be obtained and published at the logging frequency.

If the GPS option and the "Synchronize automatically" option on the "Clock" tab are enabled, the device will automatically synchronize the date and time according to information obtained by the GPS.



**The GPS receiver requires continuous visibility with satellites.
There is no reception in tunnels, closed rooms, or covered garages. Reception may be impaired in urban valleys.**

The GPS function can be used simultaneously with the SMS function, and if enabled, its position can be queried via SMS commands.

Once requested, the device will send the following replies via SMS (considering a hypothetical situation):

Reading OK	
Command	Response
<pass#1234 stsgps?>	<12:54:27 13/11/2017 "LogBox 3G" stsgps?GPS_"www.google.com.br/maps/place/-30.014662,-51.210102">

Table 29 – Reading OK

As shown on **Table 28**, the device will return a Google Maps link with its current position. To access it, the Google Maps application needs to be installed on the linked telephone. The link can also be checked in any Internet browser.

GPS Disabled	
Command	Response
<pass#1234 stsgps?>	<12:54:27 13/11/2017 "LogBox 3G" stsgps?GPS_Des>

Table 30 – GPS Disabled

No GPS Signal	
Command	Response
<pass#1234 stsgps?>	<12:54:27 13/11/2017 "LogBox 3G" stsgps?GPS_NoFix>

Table 31 – No GPS Signal

For information about how to send commands and about other available commands, see [SMS](#) chapter.

13. CONFIGURATION SOFTWARE

The **NXperience** software is the main tool for configuring, downloading, and analyzing data for **LogBox 3G**. It allows for exploring all features and resources offered by the device, communicating locally via USB interface or remotely via **NOVUS Cloud**. It is also a complete tool for analyzing data logged by the **LogBox 3G**.

NXperience allows for joint graphic analysis of multiple data, performing mathematical calculations, issuing reports, and exporting data to multiple formats. It allows for downloading data already published to **NOVUS Cloud** and, as backup, the last 140,000 logs that are in the memory (this procedure should be performed via USB interface).

NXperience is a complete configuration tool for the new **NOVUS** device line. This manual describes the specific software functions relevant to **LogBox 3G**. For instructions about the other features in this comprehensive tool, refer to the **NXperience** operating manual. The software and its respective manual can be downloaded free of charge from our website www.novusautomation.com, in the Downloads Area.

13.1 CONFIGURING LOGBOX 3G WITH NXPERIENCE

LogBox 3G is configured via **NXperience**, which allows for configuration via USB interface or remote configuration via **NOVUS Cloud**. Following is a description of each of the possible configuration parameters, grouped by sections:

13.1.1 GENERAL PARAMETERS

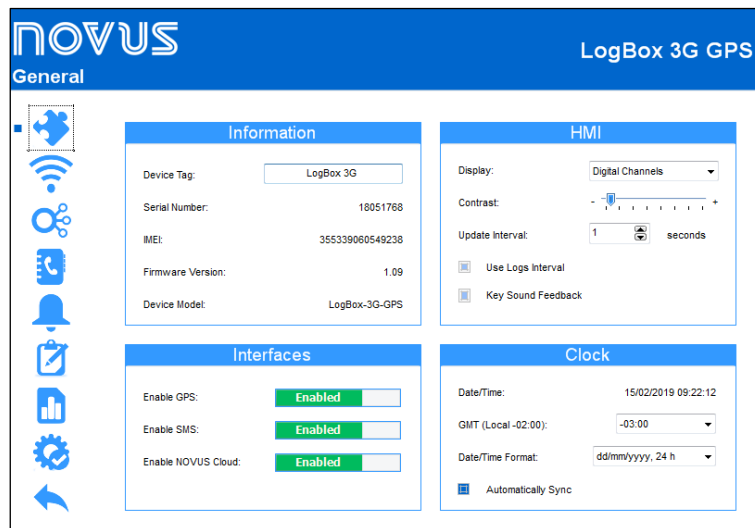

Figure 9 – General Configuration Screen

13.1.1.1 INFORMATION

- **Device Tag:** Allows for configuring a name to be used as identification during a download, on **NOVUS Cloud** and in SMS events. The field accepts up to 20 characters.
- **Serial Number:** Displays the device's unique identification number. The serial number is also used to register the device in **NOVUS Cloud**.
- **IMEI:** Displays the unique identification number of the device mobile network interface. The IMEI may be requested by some operators for registration in the network. The IMEI may need to be used to register the device in **NOVUS Cloud**.
- **Firmware Version:** Shows the firmware version stored in the device.
- **Device Model:** Displays the device model.

13.1.1.2 INTERFACES

- **Enable GPS:** Allows for enabling GPS function. Only available for the device model with GPS.
- **Enable SMS:** Allows for enabling SMS functions. To use the features, a SIM Card with an enabled SMS plan also needs to be used.
- **Enable NOVUS Cloud:** Allows for enabling **NOVUS Cloud** publication functions (see [Communicating with NOVUS Cloud](#) chapter). To use the features, a SIM Card with an enabled data plan also needs to be used.

13.1.1.3 HMI

- **Display:** Allows for selecting the display home screen on the device.
- **Contrast:** Allows for configuring the display contrast level. There are eight levels of contrast. The lowest level facilitates viewing at the upper and lower viewing angles and the highest level facilitates viewing at the front viewing angle.
- **Update Interval:** Allows for configuring how often the display information will be refreshed.
 - **Use Records Interval:** If configured, the display information will be refreshed at each logging interval.
 - **Interval:** Allows for configuring, in seconds, a display refresh interval that is shorter than the logging interval. The input channels will therefore be read and will refresh the display at this frequency. The minimum interval is 1 second and the maximum interval is 1 hour.
- **Key Sound Feedback:** Allows for enabling/disabling the sound reproduced when clicking each key.

13.1.1.4 CLOCK

- **Date/Time:** Allows for setting the date/time used to set the device clock.
- **GMT:** Allows for configuring the GMT of the place where the device will be used (preferably during first use). By default, **LogBox 3G** is set to GMT 0.
- **Date/Time Format:** Allows for configuring the clock format to 24 hours or AM/PM. If configured to 24 hours, the date format presented will be in the European standard (Day/Month/Year). If configured as AM/PM, the date format presented will be the US standard (Month/Day/Year).
- **Automatically Sync:** If selected, it allows the clock to be automatically synchronized with the **NOVUS Cloud** date and time, or if GPS is enabled, automatically synchronized with the GPS network. If not selected (not recommended), the device will assume the date and time sent upon configuration, and in the event of an electrical power outage, the device will lose the clock, stopping data logging until a new configuration is entered.

13.1.2 COMMUNICATION PARAMETERS

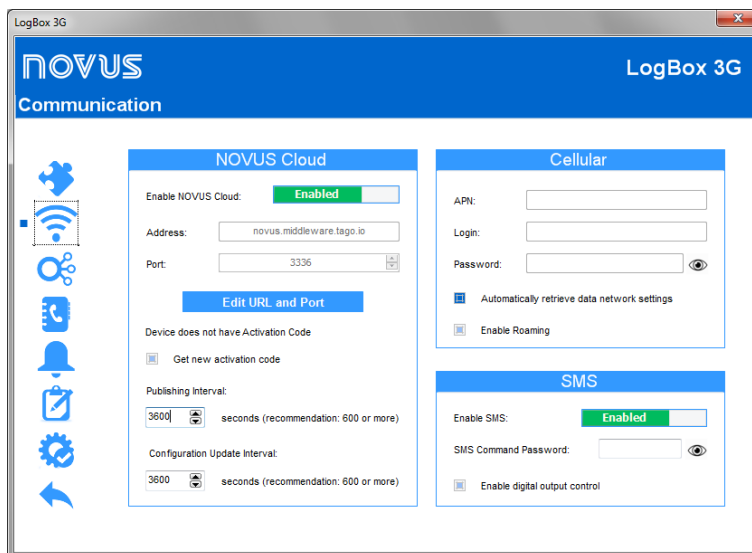

Figure 10 – Communication Screen

13.1.2.1 NOVUS CLOUD

- **Enable NOVUS Cloud:** Allows for enabling **NOVUS Cloud** publication functions (see [Communicating with NOVUS Cloud](#) chapter for additional information). To use the features, a SIM Card with enabled data plan is required.
- **Address:** Informs the platform address.
- **Port:** Informs the port number used for connecting to the platform.
- **Clear CIK:** If selected, it allows for clearing the entered CIK value. If there are connection problems or if the user wants to re-register the device in a new user account, the CIK can be cleared and restarted in the device.
- **Publishing Interval:** Allows for selecting the interval, in seconds, at which **LogBox 3G** will publish data pending in the memory to **NOVUS Cloud**. An interval longer than the logging interval can be configured. The device will thus economize data bandwidth, publishing all accumulated data at one time.
- **Configuration Update Interval:** Allows for selecting the interval, in seconds, at which the **LogBox 3G** will search for configuration updates in **NOVUS Cloud**. A short interval will cause updates to be quickly received; a longer interval, however, will consume fewer mobile data.

13.1.2.2 MOBILE NETWORK

- **APN:** Allows for configuring the Access Point Name (APN) in the device. **APN** is the telecom operator's configuration to allow access to the data network. If the operator is not pre-registered in the device (see [Mobile Network Interface](#) section), the parameter may need to be configured. If the operator is already pre-registered, the "Automatically Retrieve Data Network Configurations" option should be selected.
- **Login:** If the **APN** needs to be configured, the "Login" parameter should be filled in with the login provided by the mobile network operator. If the operator does not provide a login, the field should be left blank.
- **Password:** If the **APN** needs to be configured, the "Password" parameter should be filled in with the password provided by the mobile network operator. If the operator does not provide a password, the field should be left blank.
- **Automatically Retrieve Data Network Settings:** If selected, the device will try to automatically identify the APN configurations for access to the data network. If the device is unable to access the data network, the APN configurations provided by the operator should be checked and the parameters should be entered manually.
- **Enable Roaming:** If selected, it allows the device to try and use the network of other operators when in an area without signal coverage for the operator of the inserted SIM Card. Check with the contracted mobile network operator to find out if your plan includes Roaming network use.

13.1.2.3 SMS

- **Enable SMS:** Allows for enabling SMS services in the device.
- **SMS Command Password:** Allows for setting a password for restricting access to SMS commands.
- **Enable Digital Output Control:** If selected, it allows the digital output to be enabled or disabled via SMS commands.

13.1.3 ANALOG CHANNEL PARAMETERS

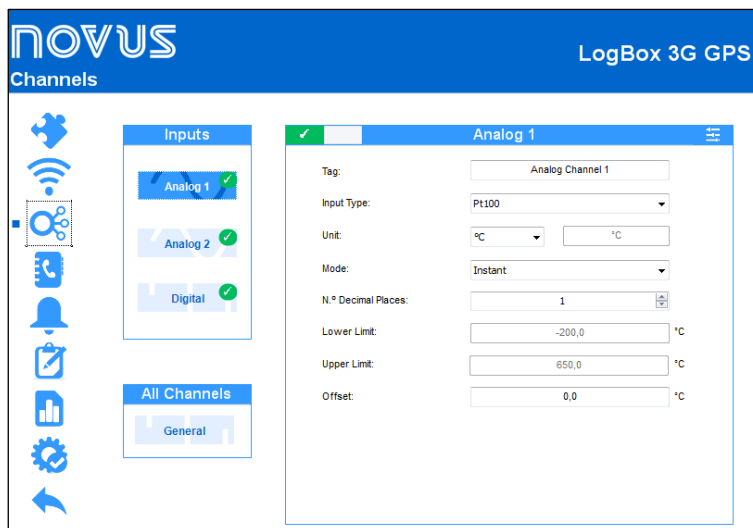



Figure 11 – Analog Channels Screen

13.1.3.1 INFORMATION

- **Tag:** Allows for configuring a name to be used as channel identification for the digital channel. The field accepts up to 16 characters.
- **Input Type:** Allows for configuring the type of sensor to be used in each analog channel.
- **Unit:** Allows for configuring the unit for each analog channel. In the case of temperature sensors, °C or °F units can be selected. For other sensors, the unit can be described with up to eight characters.
- **Mode:** Allows for configuring the operating mode to use for each analog channel. If "Instant" mode is selected, the channel will be read, and the value will be logged at each logging interval. If "Mean" mode is selected, the device will take 10 channel readings within the logging interval and at each logging interval the mean of these 10 readings will be logged.
- **No. of Decimal Places:** Allows for configuring the number of decimal places for each analog channel. Temperature Sensors can be configured to display up to one decimal place. Other sensor types can be configured to display up to two decimal places.
- **Lower Limit:** If the sensor configured for the channel is a temperature or internal diagnostic sensor, the lower limit will be filled in by the software with the sensor's lower limit. If the sensor configured for the channel is the linear sensor type (mV, V, or mA), the desired value will need to be entered to represent the minimum value for the chosen sensor.
- **Upper Limit:** If the sensor configured for the channel is a temperature or internal diagnostic sensor, the upper limit will be filled in by the software with the sensor's upper limit. If the sensor configured for the channel is the linear sensor type (mV, V, or mA), the desired value will need to be entered to represent the maximum value for the chosen sensor.
- **Offset:** Allows for making small adjustments to the readings from each channel. The configured offset will be added to all readings taken on the configured channel.

13.1.3.2 CUSTOM CALIBRATION

The  icon opens the custom calibration screen, which allows for adjusting up to 10 measurement points for each channel. When a custom calibration has been configured, the minimum number of setpoints is two points.

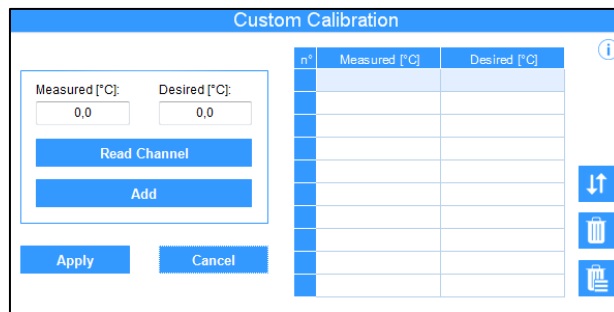





Figure 12 – Custom Calibration Screen

- **Measured:** Displays the value read from the device for which a correction is needed. It can be obtained by clicking the "Read Channel" button or filled in manually.
- **Desired:** Displays the user's desired value for the value measured from the device. It must be filled in manually.
- **Read Channel:** Allows for obtaining values from the device during custom calibration.
- **Add:** Allows for entering the "Measured" and "Desired" parameters on the custom calibration table.
- **Modify:** Allows for editing the "Measured" and "Desired" parameters on the custom calibration table.
- **Organize** : Allows for sorting the custom calibration table.
- **Delete** : Allows for deleting the selected line from the custom calibration table.
- **Delete All** : Allows for deleting the entire custom calibration table.
- **Apply:** Allows for applying the custom calibration to the channel being configured.
- **Cancel:** Allows for canceling the custom calibration operation.

13.1.4 DIGITAL CHANNEL PARAMETERS

13.1.4.1 "PULSE COUNT" MODE

14.2.3.4.1 "PULSE COUNT" MODE: FLOW RATE

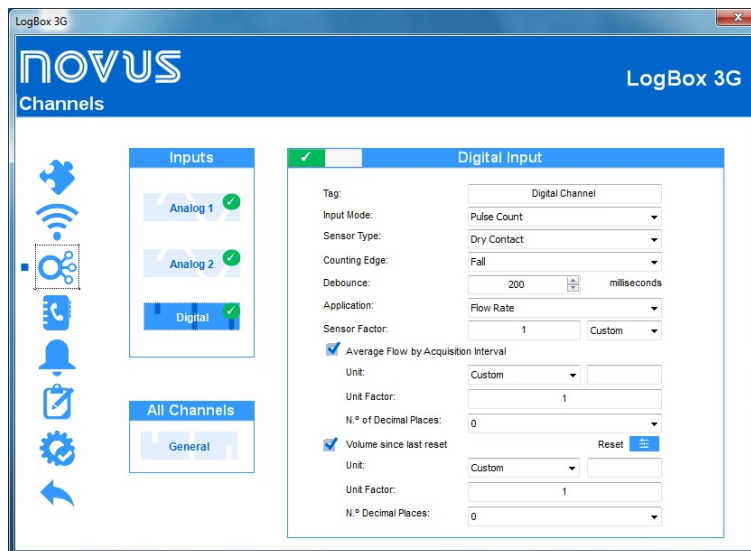

Figure 13 – Digital Input Screen: Count Mode: Flow Rate

- **Tag:** Allows for configuring a name to be used as identification for the digital channel. The field accepts up to 16 characters.
- **Input Type:** Allows for selecting the digital input mode. In this case, "Pulse Count" mode.
- **Sensor Type:** Allows for configuring the sensor type to be connected to the digital input: PNP, NPN or Dry Contact.
- **Count Edge:** Allows for configuring the desired count edge. The device will thus increase counts whenever the configured edge is detected at the digital input. The count can be performed during the rising edge, falling edge or both.
- **Debounce:** If the configured sensor type is Dry Contact, a debounce time will need to be configured for edge detection. Debounce is the sensor stabilization time – the minimum time at which the sensor must remain at the logical level of interest for the detected edge to be considered valid. The minimum configurable debounce time is 50 milliseconds; the maximum is 6 seconds.
- **Application:** Allows for selecting the application type of the digital input. In this case, the type "Flow Rate".

- **Sensor Factor:** Allows for configuring the sensor factor used at the digital input. This parameter can be found in the sensor manual as *k-factor*. **LogBox 3G** provides three units for the sensor. The custom unit option can be selected to meet any need not previously listed by the device (see [Pulse Count](#) section).
- **Average Flow by Acquisition Interval:** Allows for configuring the device to log the average flow rate per acquisition interval.
 - **Unit:** Allows for configuring the flow rate unit related to the pulses counted at the digital input. **LogBox 3G** provides nine flow units. The custom unit option can be selected to meet any need not previously listed by the device. If this option is selected, the "Sensor Factor" and its respective unit need to be configured for the device to take counts and displays the flow rate in the configured unit.
 - **Custom:** Allows for configuring a custom unit for the digital input. The field allows for describing the unit with up to eight characters. If a custom unit is configured, the "Sensor Factor" parameter will need to be configured. See [Pulse Count](#) section.
 - **Unit Factor:** If the "Unit" parameter or "Sensor Factor" unit are configured in "Custom" mode, the "Unit Factor" parameter will need to be configured. The unit factor should relate the required unit to the sensor unit and the sensor factor will be used as a factor to be multiplied in the counts read from the digital input (see [Pulse Count](#) section).
 - **No. of Decimal Places:** Allows for configuring the desired number of decimal places for displaying the calculated value, in flow, from the digital input.
- **Volume Since Last Reset:** Allows for configuring the device to log the volume since the last reset.
 - **Unit:** Allows for configuring the flow unit related to the pulses counted at the digital input. **LogBox 3G** provides nine flow units. If one of them is selected, the "Sensor Factor" and its respective unit need to be configured for the device to take counts and displays the flow rate in the configured unit. The custom unit option can be selected to meet any need not previously listed by the device.
 - **Custom:** Allows for configuring a custom unit for the digital input. The field allows for describing the unit with up to eight characters. If a custom unit is configured, the "Sensor Factor" parameter will need to be configured. See [Pulse Count](#) section.
 - **Unit Factor:** If the "Unit" parameter or "Sensor Factor" unit are configured in "Custom" mode, the Unit Factor will need to be configured. The unit factor should relate the required unit to the sensor unit and the sensor factor will be used as a factor to be multiplied in the counts read from the digital input (see [Pulse Count](#) section).
 - **No. of Decimal Places:** Allows for configuring the desired number of decimal places for displaying the calculated value, in flow, from the digital input.
 - **Reset:** See [Accumulator Resetting](#) section.

14.2.3.4.2 "PULSE COUNT" MODE: COUNT

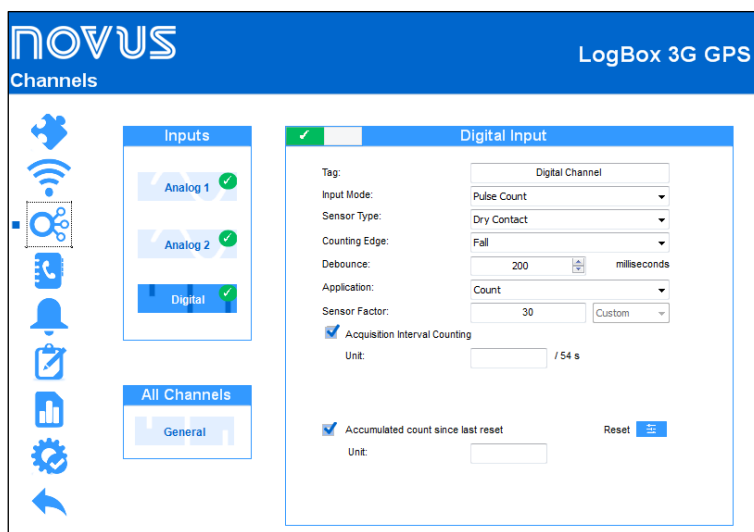

Figure 14 – Digital Input Screen: Count Mode: Count

- **Tag:** Allows for configuring a name to be used as identification for the digital channel. The field accepts up to 16 characters.
- **Input Type:** Allows for selecting the digital input mode. In this case, "Pulse Count" mode.
- **Sensor Type:** Allows for configuring the sensor type to be connected to the digital input: PNP, NPN or Dry Contact.
- **Count Edge:** Allows for configuring the desired count edge. The device will thus increase counts whenever the configured edge is detected at the digital input. The count can be performed during the rising edge, falling edge or both.
- **Debounce:** If the configured sensor type is Dry Contact, a debounce time will need to be configured for edge detection. Debounce is the sensor stabilization time – the minimum time at which the sensor must remain at the logical level of interest for the detected edge to be considered valid. The minimum configurable debounce time is 50 milliseconds; the maximum is 6 seconds.
- **Application:** Allows for selecting the application type of the digital input. In this case, the type "Count".
- **Sensor Factor:** Allows for configuring the sensor factor used at the digital input. This parameter can be found in the sensor manual as *k-factor*. **LogBox 3G** provides three units for the sensor. The custom unit option can be selected to meet any need not previously listed by the device.
- **Acquisition Interval Counting:** Allows for counting the logged count during the acquisition intervals.
 - **Unit:** Allows for configuring a custom unit for the count performed per acquisition interval. The field allows you to describe the unit with up to eight characters.

- **Volume Since Last Reset:** Allows for counting the accumulated count since the last reset.
 - **Unit:** Allows for configuring a custom unit for the count performed per acquisition interval. The field allows you to describe the unit with up to eight characters.
 - **Reset:** See [Accumulator Resetting](#) section.

14.2.3.4.3 ACCUMULATOR RESETTING

Figure 15 – Accumulator resetting

- **By SMS:** If selected, allows the reset to be performed by means of an SMS. See [SMS](#) section.
- **Periodic:** If selected, allows to set the reset to be performed daily, weekly, or monthly, and you can add time, day of the week or date.

13.1.4.2 "EVENT LOGGING" OR "LOG CONTROL" MODE

Figure 16 – Digital Input Screen: Event Mode

- **Tag:** Allows for configuring a name to be used as identification for the digital channel. The field accepts up to 16 characters.
- **Input Type:** Allows for selecting the digital input mode, which has the "Pulse Count", "Event Logging" or "Log Control" options. If "Log Control" mode is selected, the "By Digital Input" mode should be selected in the "Start Mode" and "End Mode" parameters on the "Data Logs" screen. Otherwise, the configuration will have no effect.
- **Sensor Type:** Allows for configuring the sensor type to be connected to the digital input: PNP, NPN or Dry Contact.
- **Event Edge:** Allows for configuring the desired event edge. The device will thus log events whenever the configured edge is detected at the digital input. In "Event Logging" mode, logging can be configured to record at the rising, falling or both edges. In "Log Control" mode, the user can choose to control logs at the rising, falling or both edges, logging at logical level '1' or logical level '0'.
- **Debounce:** A debounce time will need to be configured for edge detection. Debounce refers to the sensor stabilization time – the minimum time at which the sensor must remain at the logical level of interest for the detected edge to be considered valid. The minimum configurable debounce time is 50 milliseconds; the maximum is 6 seconds. The device will only record the event after the end of the debounce time. As such, the event will be logged with a delay equal to the debounce time.

13.1.5 GENERAL CHANNEL PARAMETERS

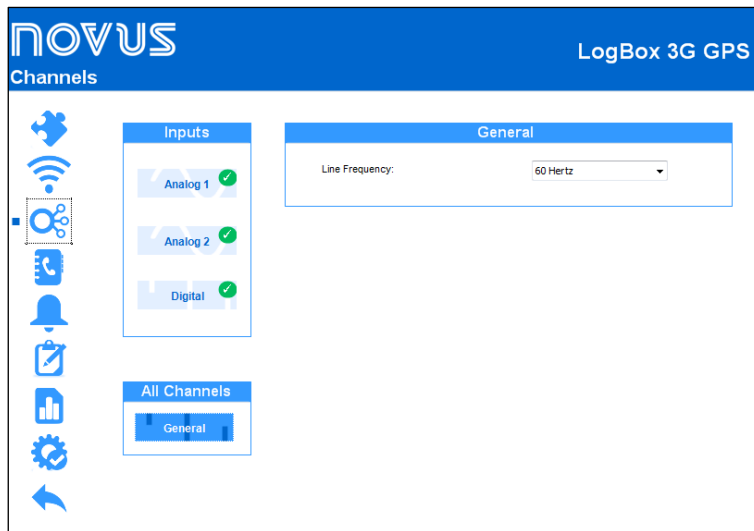

Figure 17 – Digital Input Screen: General Configurations

- **Line Frequency:** Allows for configuring the local power grid frequency (50 Hz or 60 Hz) for the device to perform better.

13.1.6 CONTACTS TO SEND SMS

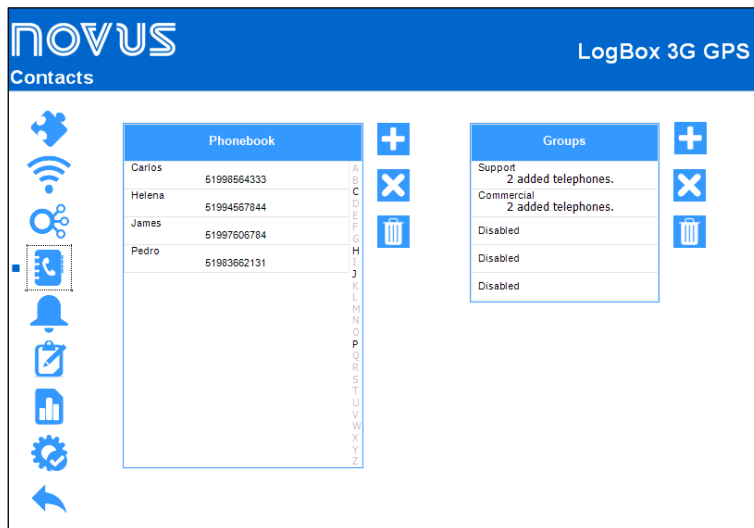

Figure 18 – Contacts Screen

13.1.6.1 PHONEBOOK

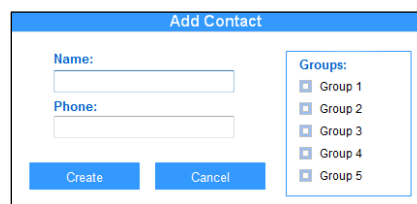





Figure 19 – Add Contact

- **Phonebook:** Allows for adding up to 20 contacts that can later be included in groups or not, to receive SMS messages related to the device alarm situations. The DDI, DDD codes and area code will need to be tested whenever a contact is entered, considering that each region and operator has its own information standard. The device is unable to identify properly. A test is recommended to ensure that the device can send SMS in case of events.
- **Add **: Allows for adding a contact to the contact list.
- **Delete **: Allows for deleting the selected contact from the contact list.
- **Delete All **: Allows for deleting entire contact list.

13.1.6.2 GROUPS

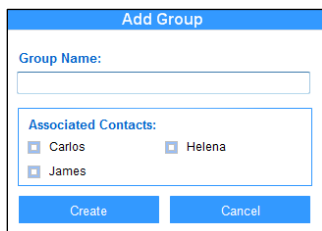





Figure 20 – Add Group

- **Groups:** Allows for adding up to 5 groups with 20 contacts that can later be selected receive SMS messages related to the device alarm situations.
- **Add **: Allows for adding a group to the group list.
- **Delete **: Allows for deleting a selected group from the group list.
- **Delete All **: Allows for deleting entire group list.

13.1.7 ALARM CONFIGURATION

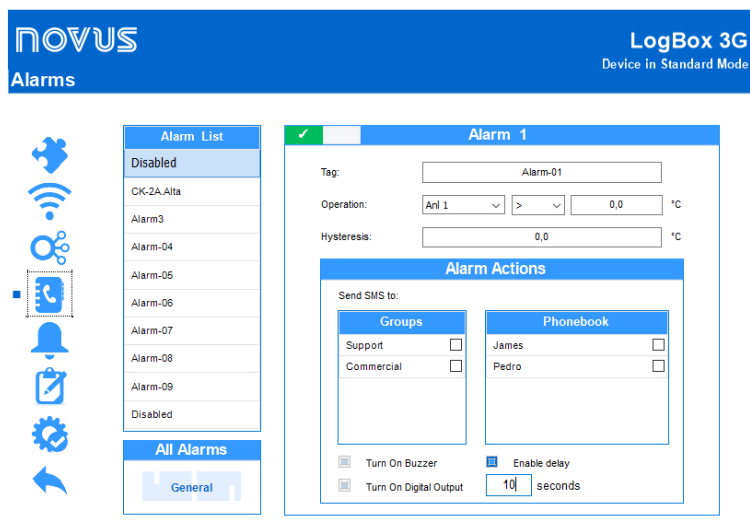

Figure 21 – Alarms Screen

Alarm configuration allows for configuring up to 10 specific alarm conditions for the device to take certain actions. Among these actions, SMS sending and buzzer and/or digital output triggering can be configured for when the configured alarm situation is reached.

- **List of Alarms:** Allows for selecting the desired alarm to be configured.
- **Tag:** Allows for configuring a name to be used as identification for the alarm. The field accepts up to 16 characters.
- **Operation:** Allows for comparing one of the variables measured by **LogBox 3G** against a value so that the device identifies the situation and takes the actions configured for that alarm.
- **Hysteresis:** Allows for configuring a hysteresis for the configured alarm condition.
- **Alarm Actions:**
 - **Send SMS to:** Allows for linking groups and/or contacts to receive SMS messages when the device identifies the configured alarm situation.
 - **Turn on Buzzer:** If selected, it configures the device to trigger the buzzer when it identifies the configured alarm situation.
 - **Turn on Digital Output:** If selected, it configures the device to trigger the digital output when it identifies the configured alarm situation.
 - **Enable delay:** Allows you to enable the delay of configured alarm. Once enabled, the device will only consider an alarm if the setpoint is exceeded and maintained for a timer longer than the configured delay.
 - **Configure seconds:** Allows you to configure the delay period to be considered. Maximum value: 3600 seconds.

13.1.7.1 GENERAL

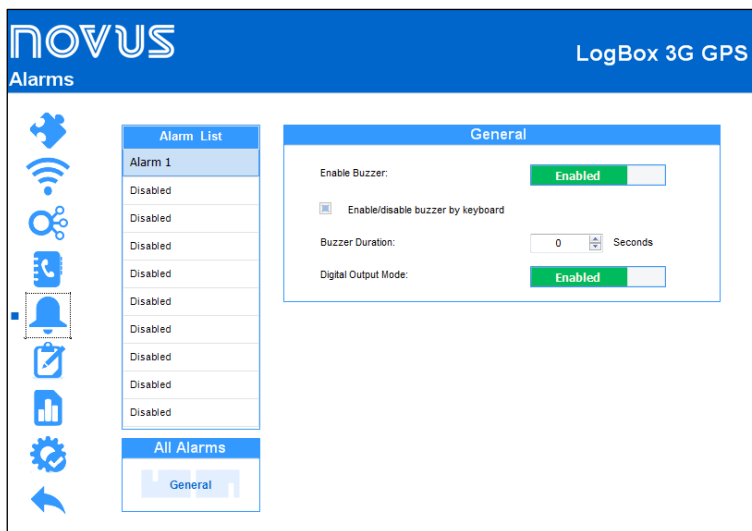

Figure 22 – General Alarm Screen

- **Enable Buzzer:** Allows for generally enabling or disabling buzzer functions. If disabled, the buzzer will not be triggered when the device reaches an alarm situation.
- **Enable/Disable Buzzer by Keyboard:** If selected, it lets the user mute the buzzer by pressing any key when it is sounding during an alarm situation.
- **Buzzer Duration:** Allows for setting the buzzer duration for each time the device enters an alarm situation. The configuration will be in seconds, from 0 to 65000 s, where 0 means that the buzzer should not be triggered.
- **Enable Digital Output:** Allows for generally enabling or disabling digital output functions. If disabled, the digital output will not be triggered when the device reaches an alarm situation.

13.1.8 DATA LOG CONFIGURATION

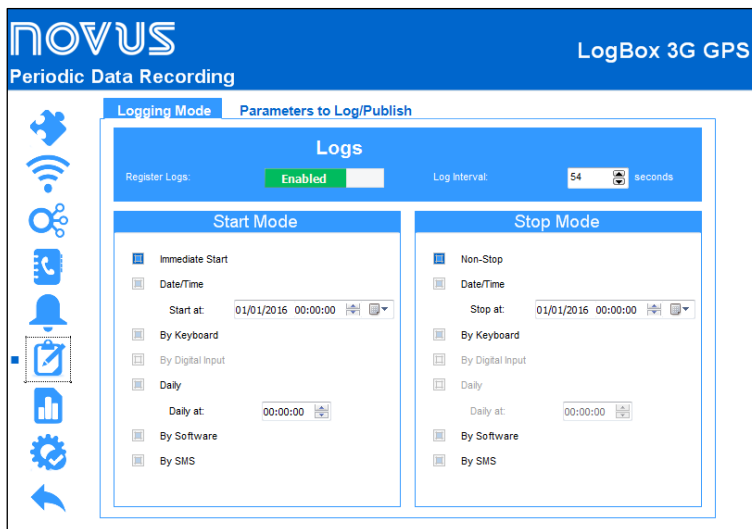

Figure 23 – Data Logging Screen: Mode

13.1.8.1 LOGS

- **Register Logs:** Allows for enabling or disabling data logging on the device. If the device is not logging, the data will not be published to **NOVUS Cloud**.
- **Log Interval:** Allows for selecting the frequency, in seconds, at which an acquisition must be made and saved in the memory.
 - **Minimum Interval:** 1 seconds.
 - **Maximum Interval:** 12 hours.

13.1.8.2 START MODE

- **Immediate Start:** Allows logs to be started shortly after the device is reconfigured.
- **Date/Time:** Allows for setting the date/time when logs should be started.
- **By Keyboard:** Allows you to change the log status to enabled on a screen on the display. This starts the logs.
- **By Digital Input:** Allows logs to be started from the digital input. This parameter will be available if the digital input is enabled and configured in the "Log Control" mode. The logs will thus be started as soon as the digital input is activated. The log edge should be configured in the digital input parameters.
- **Daily:** Allows logs to be started every day and at the configured time. A "Daily" log start mode requires a "Daily" log end mode.

- **By Software:** Allows logs to be started via an NXperience command (the command will only be available when using the USB interface).
- **By Software:** Allows logs to be started via an SMS command.

13.1.8.3 END MODE

- **Non-Stop:** Allows logging to continue indefinitely.
- **Date/Time:** Allows for setting the Date/Time when the logs should be concluded.
- **By Keypad:** Allows for changing the log status to disabled on a display screen, stopping logging.
- **By Digital Input:** Allows logging to be paused at the digital input. This parameter will be available if the digital input is enabled and configured in the "Log Control" mode. The logs will thus be paused as soon as the digital input is activated. The log edge should be configured in the digital input parameters.
- **Daily:** Allows logging to be concluded every day and at the configured time. A "Daily" log end mode requires a "Daily" log start mode.
- **By Software:** Allows logs to be started via an NXperience command (the command will only be available when using the USB interface).
- **By Software:** Allows logging to be concluded via an SMS command.

The permitted combinations for starting and ending logs are as follows:

START MODE	END MODES
Immediate	Non-Stop or Date/Time or Keypad or Digital Input or Software or SMS
Date/Time	Non-Stop or Date/Time or Keypad or Digital Input or Software or SMS
Digital Input	Non-Stop or Digital Input
Keyboard	Keyboard
Software	Software
Daily	Daily
SMS	SMS

Table 32 – Log termination modes

13.1.8.4 PARAMETERS TO LOG/PUBLISH

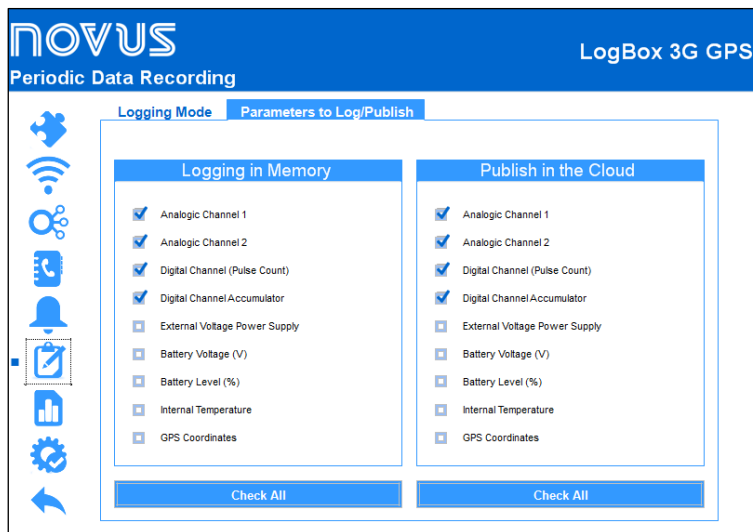

Figure 24 – Data Logging Screen: Local

This screen allows for selecting which data will be recorded to the device's data memory ("Data Memory" tab) and which data will be published to **NOVUS Cloud** ("Cloud" tab). The information can be saved simultaneously. To publish to **NOVUS Cloud**, data logging in the memory is required.

13.1.8.4.1 DATA MEMORY

- **Analog Channel 1:** Enables/disables logging of analog channel 1 information.
- **Analog Channel 2:** Enables/disables logging of analog channel 2 information.
- **Digital Channel:** Enables/disables logging of periodic information about the digital channel. If the digital channel is in "Event Logging" or "Log Control" mode and if this operation is enabled, the device will record the status of the digital input in the Logging Interval. Digital input events will be logged asynchronously, whether this option is enabled.
- **Digital Channel Accumulator:** Enables/disables logging of information about the "Accumulator" function of the digital channel.
- **External Voltage Source:** Enables/disables logging of external power supply voltage information.
- **Battery Voltage (V):** Enables/disables logging of battery voltage information.
- **Battery Level (%):** Enables/disables logging of battery level information.
- **Internal Temperature:** Enables/disables logging of information about the device's internal temperature.
- **GPS Coordinates:** Enables/disables logging of information about the device's GPS coordinates.

13.1.8.4.2 CLOUD

- **Analog Channel 1:** Enables/disables publication of analog channel 1 information.
- **Analog Channel 2:** Enables/disables publication of analog channel 2 information.
- **Digital Channel:** Enables/disables publication of periodic information about the digital channel. If the digital channel is in "Event Logging" or "Log Control" mode and if this operation is enabled, the device will record the status of the digital input in the Logging Interval. Digital input events will be logged asynchronously, whether this option is enabled.
- **Digital Channel Accumulator:** Enables/disables logging of information about the "Accumulator" function of the digital channel.
- **External Voltage Source:** Enables/disables publication of external power supply voltage information.
- **Battery Voltage (V):** Enables/disables publication of battery voltage information.
- **Battery Level (%):** Enables/disables publication of battery level information.
- **Internal Temperature:** Enables/disables publication of information about the device's internal temperature.
- **GPS Coordinates:** Enables/disables publication of information about the device's GPS coordinates.

13.1.9 FINALIZATION PARAMETERS

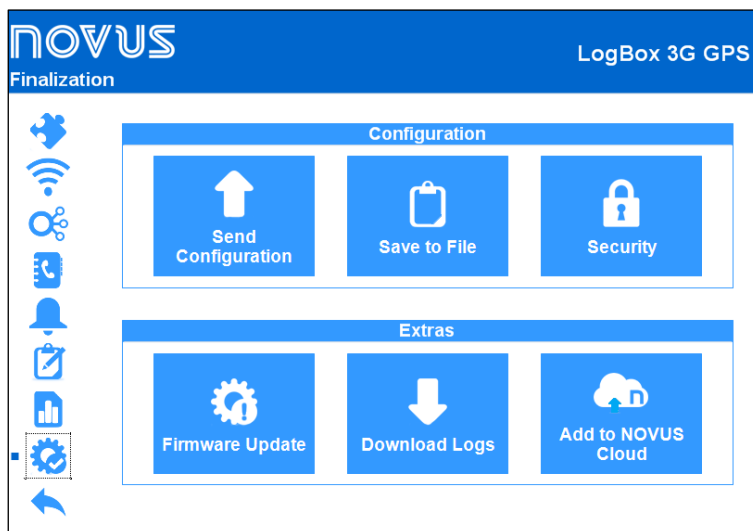

Figure 25 – Finalization screen

13.1.9.1 CONFIGURATION

- **Send Configuration:** Allows you to apply the previously configured settings to the connected device.
- **Save to File:** Allows you to save the previously configured settings to a file with .nxc extension, compatible with the NXperience software.
- **Security:** Allows you to create, change or delete the password to block access to the device settings. This parameter allows 4 to 8 alphanumeric and special characters. To remove a previously registered password, simply leave the "New Password Confirmation" field blank.

13.1.9.2 EXTRAS

- **Firmware Update:** Allows you to perform the device firmware update. Go to the product page on our web site and download the update file. Then just select this option and manually load the update file. The software will provide information about the updated firmware version, the update status, and the estimated time to update the firmware update.
- **Download Logs:** Allows you to download the device logs. Once downloaded, the software will display a graph with the information downloaded. To learn how to manipulate them, check the specific **NXperience** manual, available on our web site.
- **Add to NOVUS Cloud:** Allows you to register the device in **NOVUS Cloud**. Enter the e-mail and password of the user already registered (or select the "Click here" option to register) and click the "Register" button.

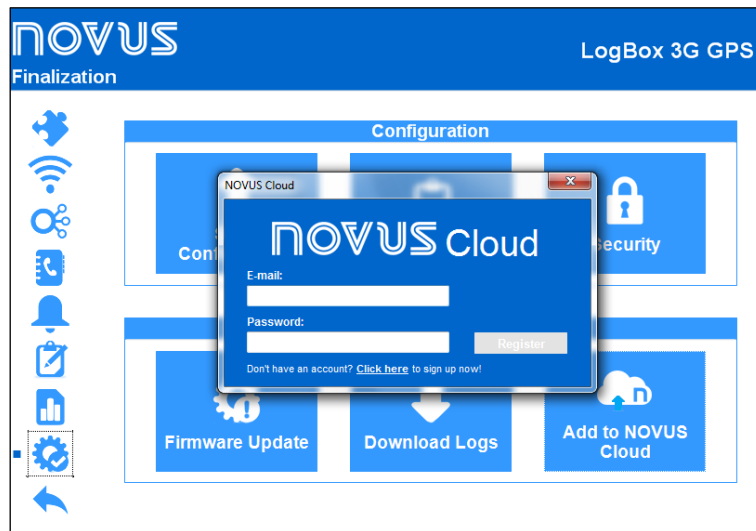

Figure 26 – Add do NOVUS Cloud

13.2 DIAGNOSTICS

The LogBox 3G configuration screen provides access to the "Diagnostics" screen. When clicked, the software will monitor some of the device statuses. The refresh interval for information on the diagnostics screen is 60 second.

Following are additional details about the monitored information:

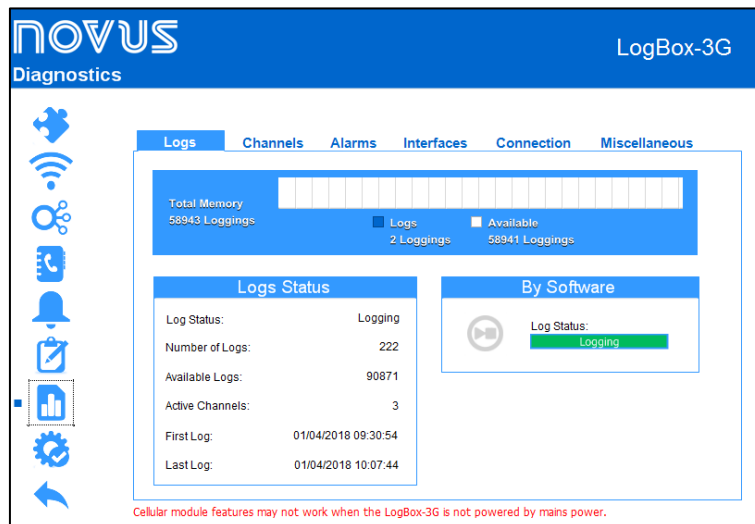

Figure 27 – Diagnostics Screen

13.2.1 LOGS

13.2.1.1 LOG STATUS

- **Log Status:** Informs whether the device is logging.
- **Number of Logs:** Informs the number of logs recorded by the device.
- **Available Logs:** Informs the number of logs that can be recorded before the memory is full.
- **Active Channels:** Informs the number of active channels.
- **First Log:** Informs the date and time of the first log recorded by the device.
- **Last Log:** Informs the date and time of the last log recorded by the device.

13.2.1.2 BY SOFTWARE

- **Log Status:** Informs whether the device is logging or not and allows for starting or pausing logs if the start and end modes "By Software" have been selected.

13.2.2 CHANNELS

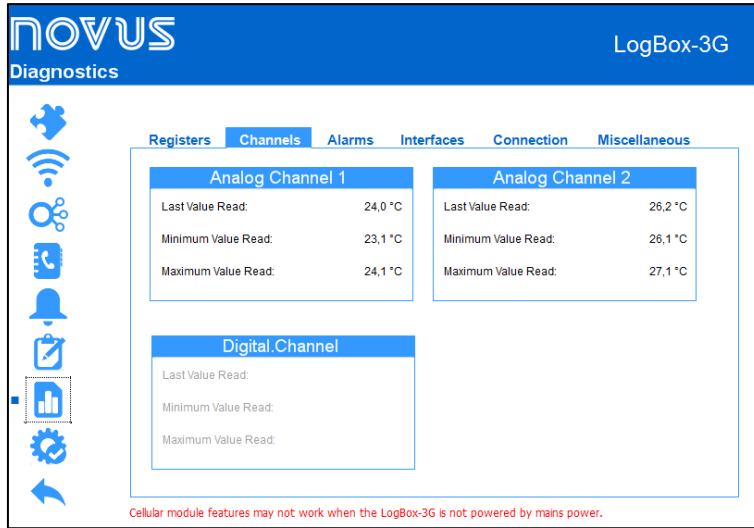

Figure 28 – Diagnostics Screen: Channels

- **Analog Channels and Digital Channel:** Displays information about the acquisitions taken by the device at the analog channel sensors and at the digital channel sensor.
 - **Last Value Read:** Displays the value of the last acquisition taken by the device at the corresponding channel sensor.
 - **Minimum Registered Value:** Informs the minimum value recorded by the device at the corresponding channel sensor.
 - **Maximum Registered Value:** Informs the maximum value recorded by the device at the corresponding channel sensor.

13.2.3 ALARMS

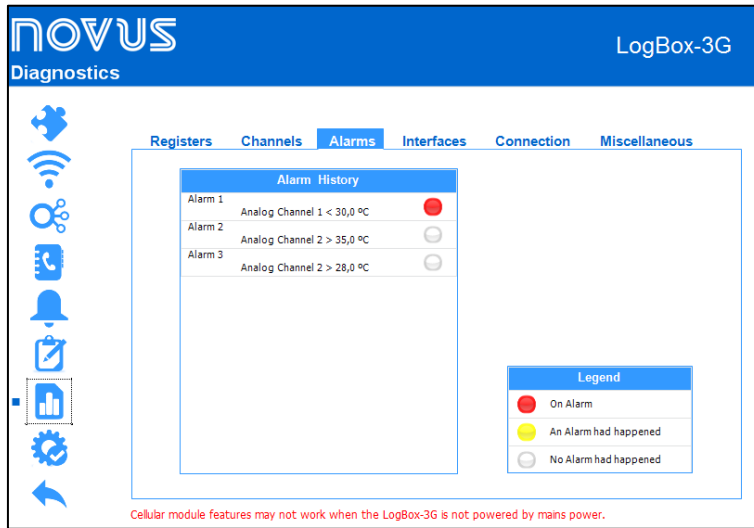

Figure 29 – Diagnostics Screen: Alarms

Displays information about the alarm history, showing its status or informing if it has already entered in alarm condition. Once the alarm is activated, the white marker light will change to red when a channel enters in alarm condition and will change to yellow to report that an alarm has occurred but that the alarm situation is no longer satisfied.

An active alarm will enter an alarm condition when the current value is greater than the setpoint set in its initial configuration.

To clear the markers, alarm recognition must be performed through the device's display (see the "Clear Alarm Status" screen in the [General Navigation Screens](#) section) or a new setting.

13.2.4 INTERFACES

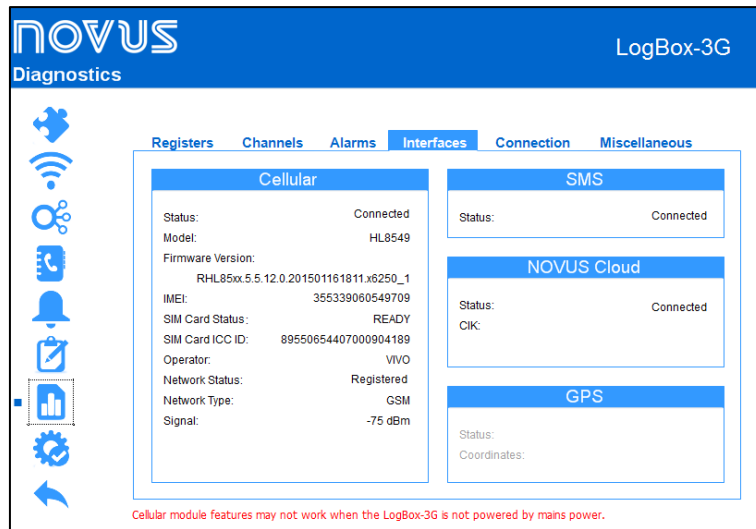

Figure 30 – Diagnostics Screen: Interfaces

13.2.4.1 CELLULAR

- **Status:** Informs the mobile network status.
- **Model:** Informs the device model.
- **Firmware Version:** Informs the device firmware version.
- **IMEI:** Informs the device registered IMEI.
- **SIM Card Status:** Informs the status of the SIM Card connected to the device. If you have problems with the connected SIM Card, check the [DiagSIM Application](#) section of the [Communication Interfaces](#) chapter.
- **SIM Card ICC ID:** Informs the ID of the SIM Card connected to the device.
- **Operator:** Informs the operator responsible for the mobile network.
- **Network Status:** Informs the mobile network status.
- **Network Type:** Informs the mobile network type.
- **Signal:** Informs the strength of the mobile network signal.

13.2.4.2 SMS

- **Status:** Informs the SMS status.

13.2.4.3 NOVUS CLOUD

- **Status:** Informs the connection status with **NOVUS Cloud**.
- **CIK:** Informs the CIK generated by the device.

13.2.4.4 GPS

- **Status:** Informs the mobile network status.
- **Coordinates:** Informs the physical location coordinates of the device.

13.2.5 CONNECTION

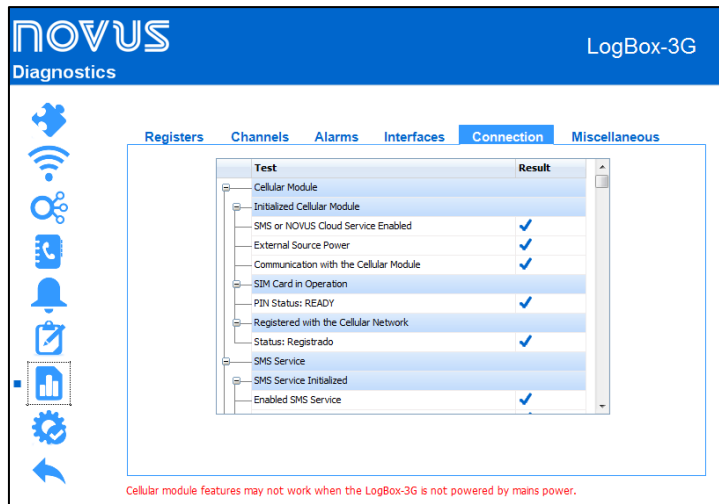

Figure 31 – Diagnostics Screen: Connection

This tab is responsible for making a diagnosis of the device connections. In the "Test" column, the software informs the name of the connection to be tested. In the "Result" column, informs if was failure or success in the connectivity test. The blue symbol corresponds to the test success result; the symbol in red, to error.

Hovering the mouse over the red error signal in the results field will provide a possible explanation for why the selected connection is presenting problems.

13.2.6 MISCELLANEOUS

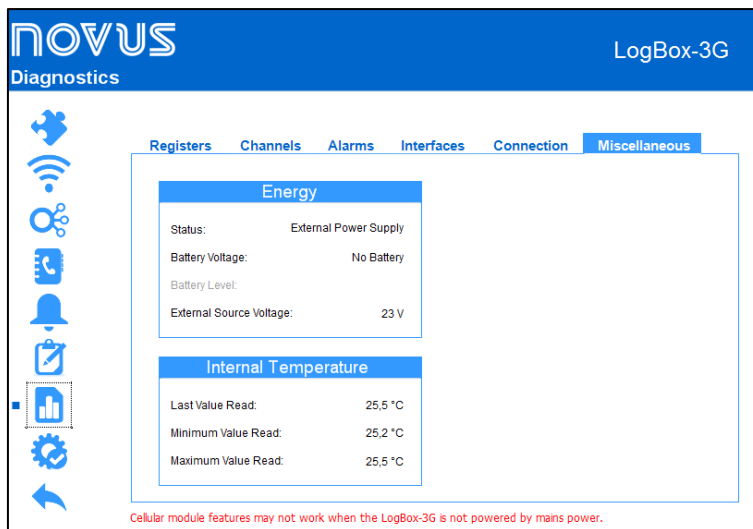

Figure 32 – Diagnostics Screen: Interfaces

- **Energy:** Provides information about the power conditions monitored by the device.
 - **Status:** Informs the current supply of power to the device.
 - **Battery Voltage:** Informs the voltage of the battery of the device and whether the device has a battery connected.
 - **Battery Level:** Informs the current battery level status.
 - **External Source Voltage:** Informs the external power supply voltage to the device.
- **Internal Temperature:** Informs the internal temperature from the device.
 - **Last Value Read:** Informs the value of the last internal temperature recorded by the device.
 - **Minimum Registered Value:** Informs the minimum temperature recorded by the device.
 - **Minimum Registered Value:** Informs the maximum temperature recorded by the device

14. INSTALLATION

14.1 MECHANICAL INSTALLATION

LogBox 3G has a high-quality casing, built in ABS+PC and with IP40 protection rating.

To make it easier to secure **LogBox 3G**, the device comes with a fixing bracket, indicated, and designed for any type of wall, which has three oblong holes arranged in a triangle for securing the device with screws. Moreover, the same fixing bracket also has 4 magnetic inserts to secure the device to metal surfaces.

To assist the installation aesthetics, two openings at the bottom of the fixing bracket can be used to pass the sensors that are connected to the device. Additionally, this bracket has a ring for placing a padlock to prevent removal of **LogBox 3G** from the installation location.

With the aid of two screwdrivers and through two lateral fittings, **LogBox 3G** can be attached to or removed.

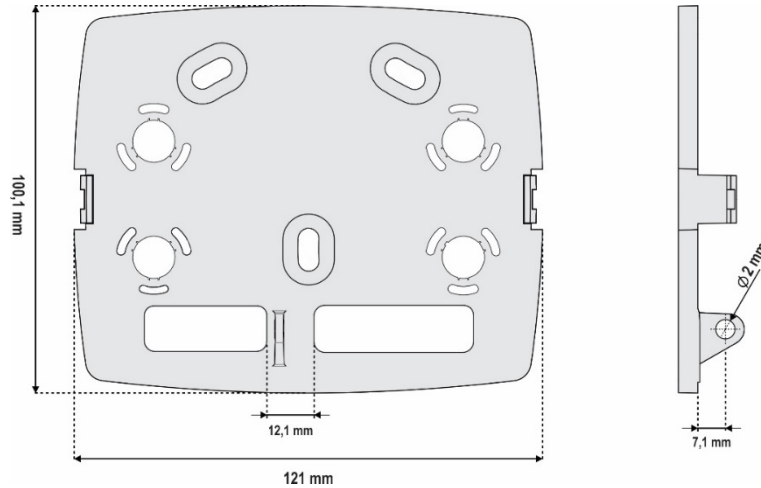

Figure 33 – Mounting Bracket

To improve the device installation aesthetics, **LogBox 3G** comes with a protective cover for connections that fits into the bottom of the device and hides its sensors. This protective cover has four detachable cavities to facilitate sensor installation.

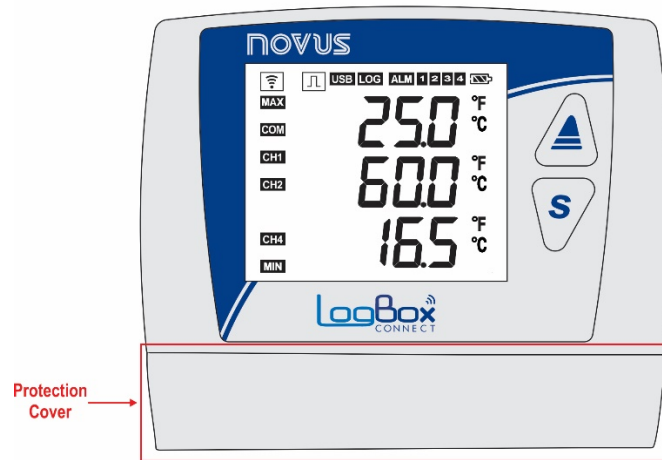

Figure 34 – Protective connection cover

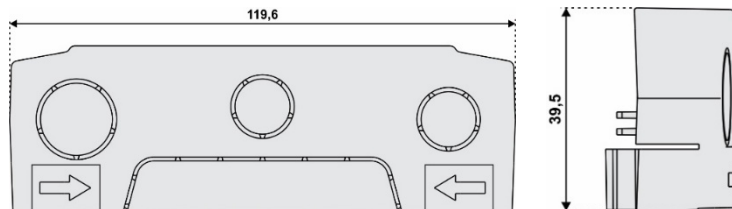

Figure 35 – Dimensions of the protective cover for detachable connections and cavities

To detach the protective cover, press the sides, one side at a time.

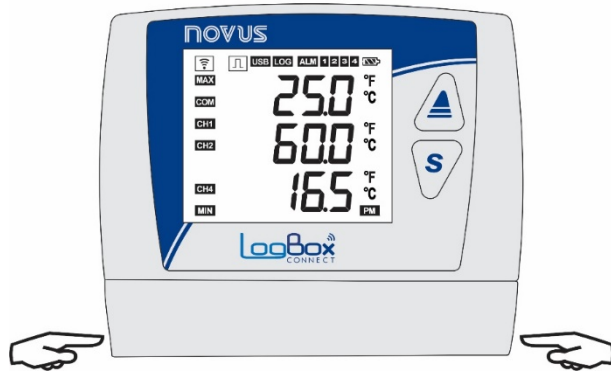

Figure 36 – Removing the protective cover

To attach the protective cover, the area designated by the arrows needs to be pressed from outside in, one side at a time.

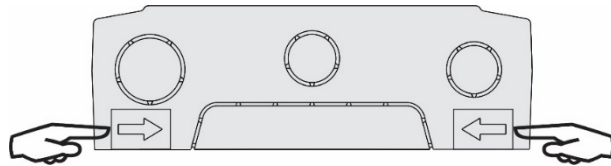

Figure 37 – Protective cover fitting

14.1.1 DIMENSIONS

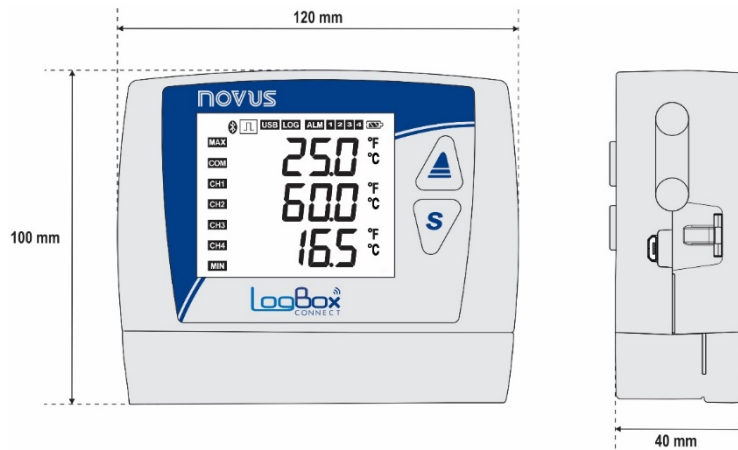

Figure 38 – LogBox 3G dimensions

14.1.1.1 DIMENSIONS OF ANTENNAS

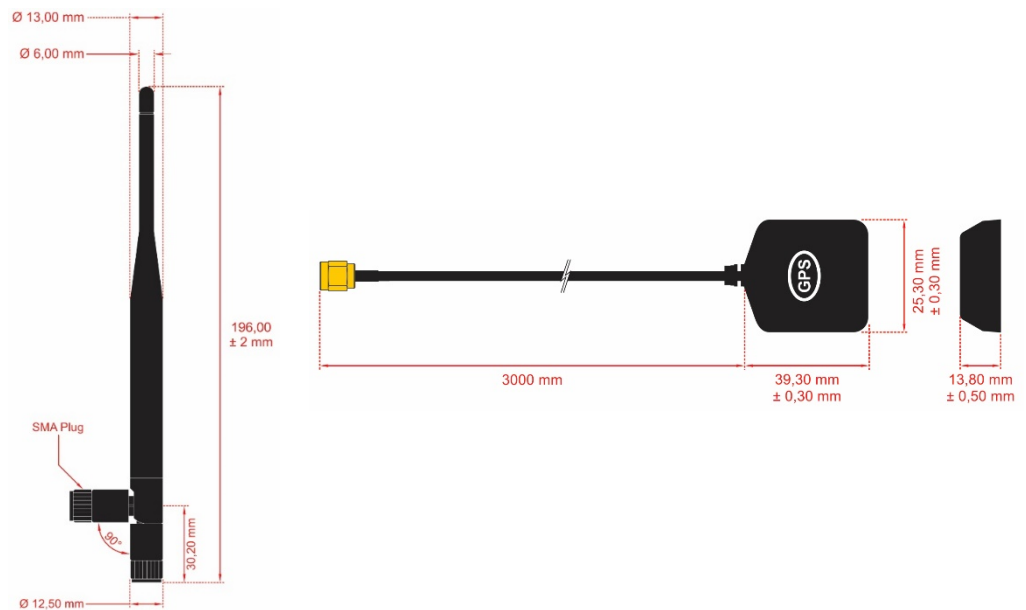

Figure 39 – Antenna dimensions (mobile network and GPS)

14.1.2 CONNECTIONS

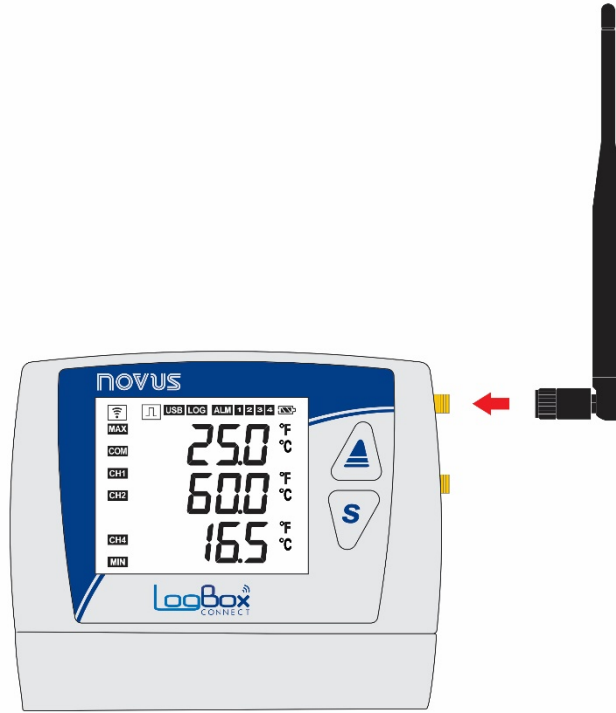

Figure 40 – Mobile network antenna

Make sure to fit the mobile network antenna to the right slot and position it vertically, pointed upward.

If the antenna needs to be positioned far from the device (to obtain better signal coverage), an antenna with extension cable and magnetic base can be purchased separately.

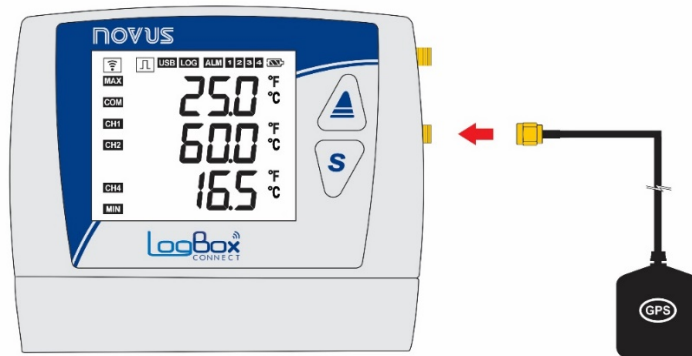

Figure 41 – GPS Antenna

Make sure to fit the GPS antenna to the right slot and position it, using its extension cable, in a preferably outdoor location that provides visibility for satellites. The GPS antenna has a magnet to make it easier to attach to metal surfaces.

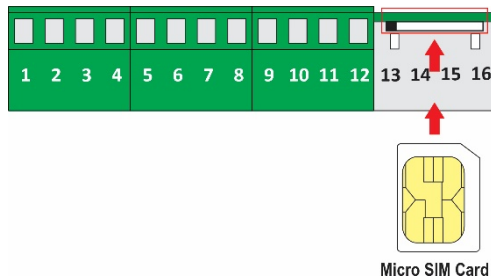

Figure 42 – Micro SIM Card connection

Make sure the device is turned off before inserting/removing the SIM Card.

14.2 ELECTRICAL INSTALLATION

14.2.1 INSTALLATION RECOMMENDATIONS

- Electronic and analog signal conduits should run through the plant separately from the output and power supply conduits. If possible, in grounded conduits.
- The power supply for electronic instruments must come from an appropriate grid for instruments.
- RC FILTERS (noise suppressor) are recommended in contactor coils, solenoids, etc.

- In control applications, it is essential to consider what could happen when some part of the system fails. The device's internal devices do not ensure total protection.
- Electrical connections must be made with the terminal blocks highlighted on the device. Before connecting them, make sure that the connections have been made correctly.
- Remember to pass all wires through the desired openings, designed for their passage, before making any electrical connections.
- The power supply, digital output, digital input, and analog input terminals are not isolated from each other. As such, analog and digital signals from the same voltage source should not be used, otherwise the device will malfunction.
- If you use thermocouple type sensors and want to use grounded thermocouples, you must take care that the installation does not generate ground loops that could influence the correct temperature measurement by the device. This could generate false offsets, reading oscillation, possibly malfunction or even burn the device. The power supply input for the **LogBox 3G** analog sensors does not have galvanic isolation. Thus, grounded sensors on application equipment may create ground loops and influence the measurement. Use insulated thermocouples or, if grounded thermocouples are required, choose a power supply that provides good galvanic isolation to the device. You can also avoid ground loops by powering the device from the battery only, with no USB or external source.

14.2.2 SPECIAL PRECAUTIONS

Because it is an electronic module, **LogBox 3G** requires some care when handling:

- Due to the risk of damage caused by static electricity and which may occur if the electronic circuit is exposed, the device should not be opened.
- Pay close attention to the sensor wires, the digital input, the digital output, and the external power supply connections.
- Make sure the device is turned off before inserting/removing the SIM Card.

14.2.3 ELECTRICAL CONNECTIONS

LogBox 3G has 3 detachable connection terminal blocks for connecting the external power supply, loading digital output, digital input sensor and analog sensors for each of the 2 available analog channels. The basic electrical connections are illustrated below:

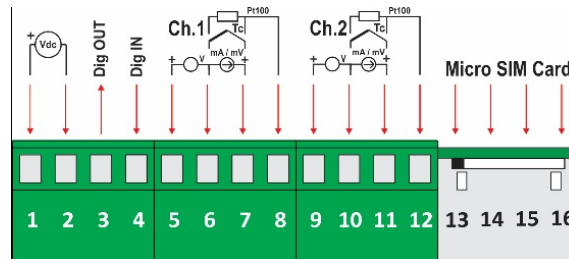

Figure 43 – Electrical Connections

To connect the sensors, the connection terminal blocks should be previously detached from the device. To facilitate sensor connection, use the numbering printed on the connectors and the electrical connection image shown in the figure above, in the Quick Guide and on the protective connection cover.

	<p>The power supply, digital output, digital input, and analog input terminals are not isolated from each other.</p> <p>As such, analog and digital signals from the same voltage source should not be used, otherwise the device will malfunction.</p>
--	---

14.2.3.1 POWER SUPPLY

	<p>The connection to the power supply is made at the terminals according to image shown. The power supply used must be of the direct current type, with voltage between 10 and 30 V, and provide a minimum current of 15 mA when no load is connected to the digital output. If the load is connected to the digital output, the power supply used must be able to provide current compatible with the load used.</p>
--	---

14.2.3.2 DIGITAL OUTPUT

	<p>The connection to the digital output is made at the terminals according to image shown. The digital output is NPN type, connecting from terminal 3 (<i>Dig Out</i>) to terminal 2 (GND) when enabled. When disabled, terminal 3 (<i>Dig Out</i>) remains at high impedance.</p>
--	--

14.2.3.3 DIGITAL INPUT

PNP Connection

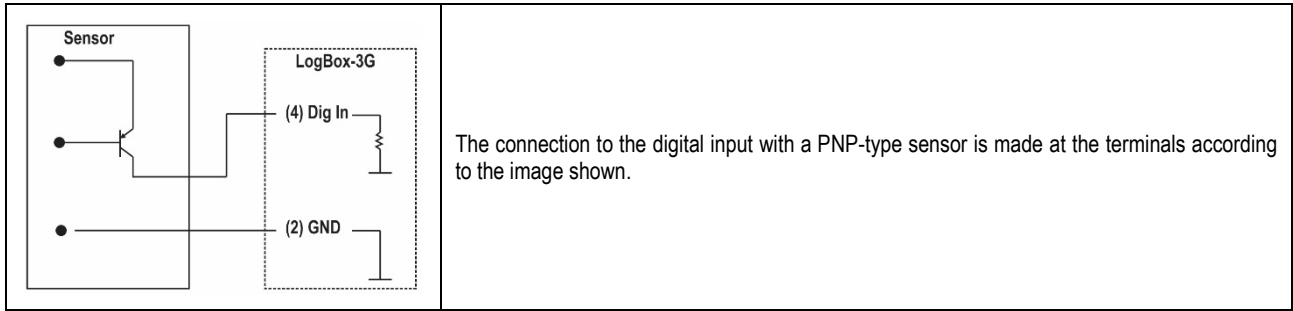

NPN Connection

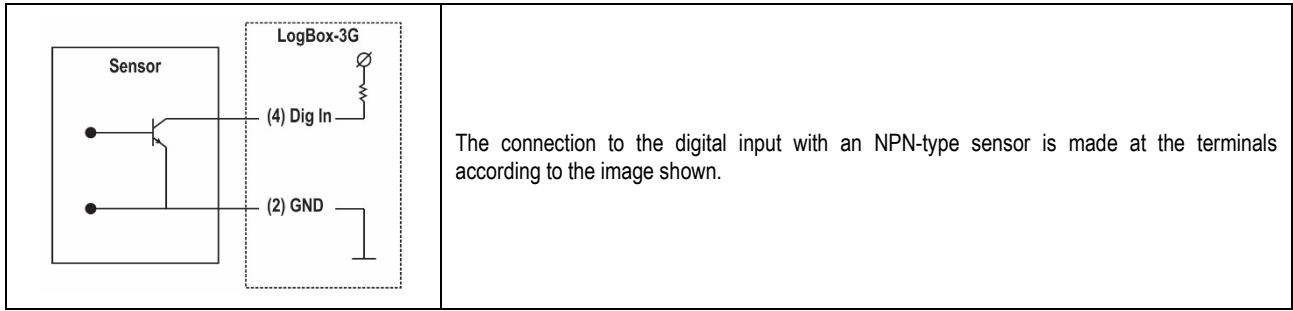

Dry Contact Connection

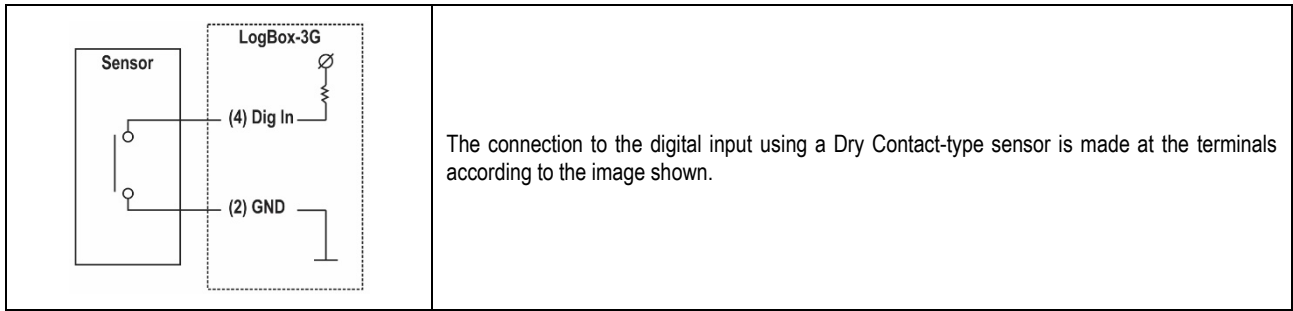

14.2.3.4 ANALOG INPUTS

Pt100 Connection

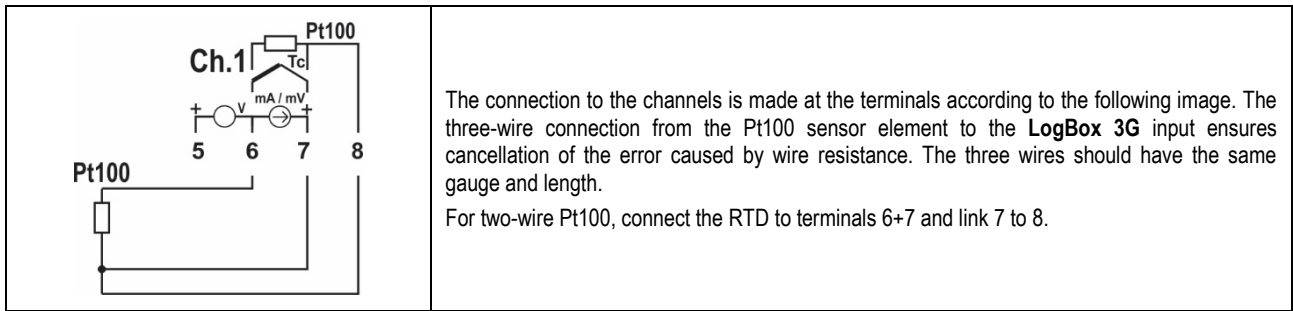

Thermocouple Connection

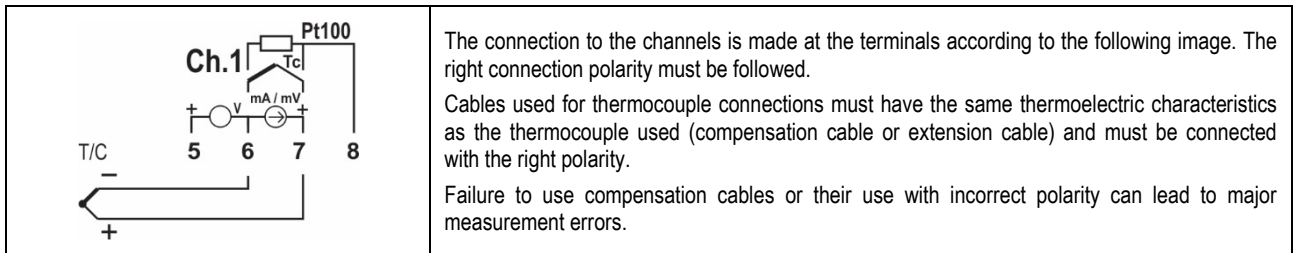

Voltage Connection (mV)

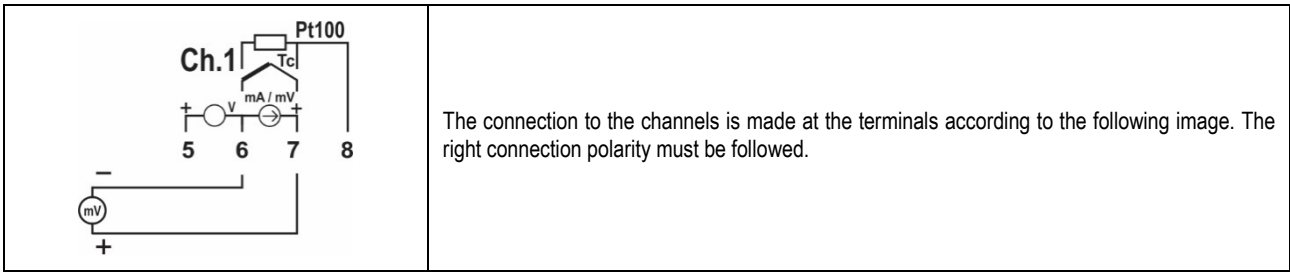

Current Connection (mA)

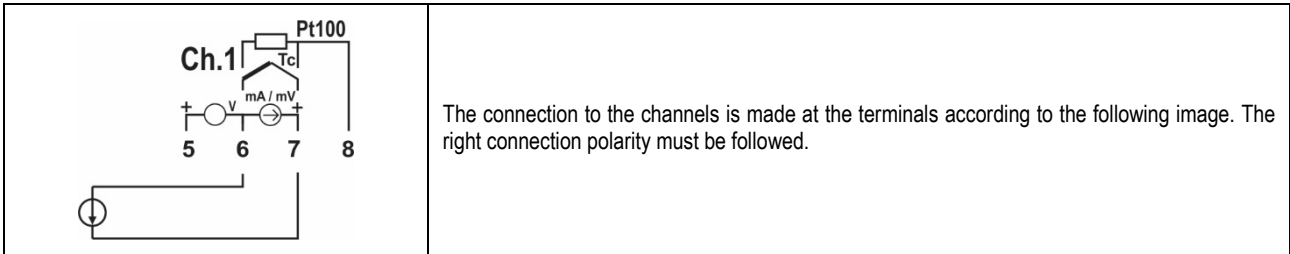

Voltage Connection (V)

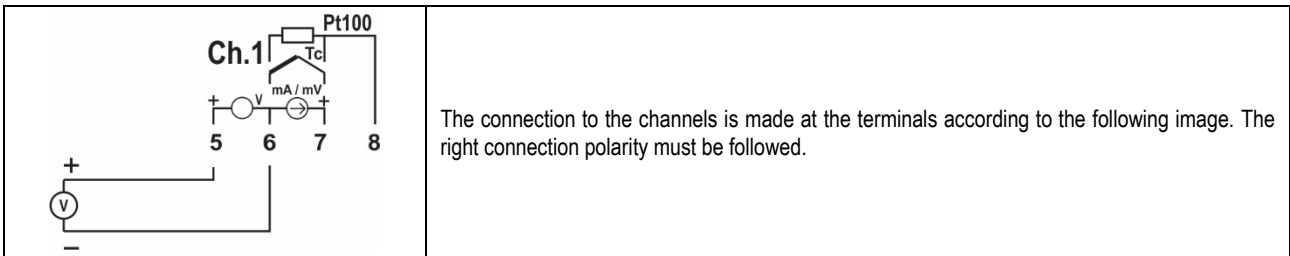

EXAMPLE OF CONNECTION OF 4-20 mA TRANSMITTERS POWERED BY THE CURRENT LOOP

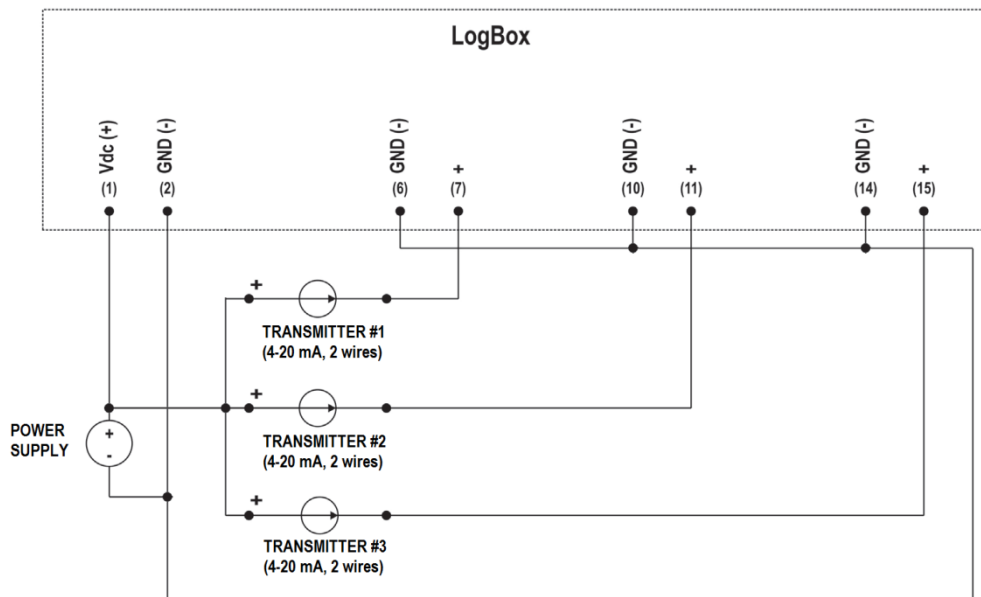



Figure 44 – Example of connecting transmitters that are fed by the loop

15. COMMUNICATION INTERFACES

15.1 USB INTERFACE

The USB interface is the preferred interface for the first configuration of the device. It is the only interface which can never be disabled. To access it, **NXperience** software for Windows needs to be installed. The USB driver will thus be installed (see [Configuration Software](#) chapter). A standard micro-USB cable (not supplied) must be used for desktop or notebook connection.

When connecting the USB cable, the respective icon should light up on the device's display, indicating that its interface is ready for use. For the first use, the user will need to wait for Windows to automatically install the driver that comes pre-installed by **NXperience**. **NXperience** will configure, monitor, and download tags from the device via USB interface.

	The USB interface IS NOT ISOLATED.
	It is intended for temporary use during CONFIGURATION, MONITORING and LOG DOWNLOAD. For the safety of people and devices, it should only be used when the device is disconnected from the external power supply.
	The USB interface can be used in any other connection condition, although the decision requires careful analysis by the person in charge of installation.

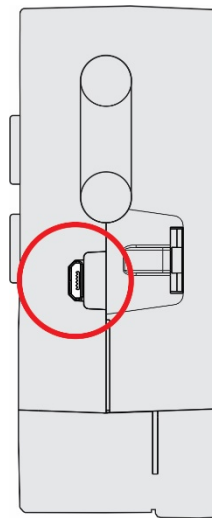

Figure 45 – USB Interface

15.2 MOBILE NETWORK INTERFACE



Figure 46 – Mobile network and GPS Interface

LogBox 3G features a mobile network interface compatible with 2G (GPRS, EDGE) and 3G (WCDMA, HSDPA, HSUPA) technologies, which provide data and SMS connection services. The data connection is exclusively for direct communication with **NOVUS Cloud**, where the device can publish logged data or look for new configurations. SMS services allow the device to send alarm events and respond to diagnostic commands. Both services may be enabled/disabled in the device's configurations, which allows the user to use the device only as a data logger, with or without alarms via SMS, publishing data in the cloud or not.

The device identification label shows the mobile module IMEI. It is the unique identifier of the mobile network module and may be requested by some operators.

LogBox 3G comes factory-configured with the APN information, required for data connection, for the main telecom operators **Table 32**). However, if the operator is not pre-registered in the device or the APN configurations have changed, a new APN, Login and Password can be configured via **NXperience**. Proper APN configuration is required for the device to have access to the data network.

TELECOM OPERATORS			
Operator	APN	Login	Password
VIVO	<i>zap.vivo.com.br</i>	<i>vivo</i>	<i>vivo</i>
CLARO	<i>claro.com.br</i>	<i>claro</i>	<i>claro</i>
TIM	<i>tim.br</i>	<i>tim</i>	<i>tim</i>
OI	<i>gprs.oi.com.br</i>	<i>oi</i>	<i>oi</i>
CTBC	<i>ctbc.br</i>	The operator does not require a value.	The operator does not require a value.
Sercontel	<i>sercontel.com.br</i>	The operator does not require a value.	The operator does not require a value.
NEXTEL	<i>wap.nextel3g.net.br</i>	The operator does not require a value.	The operator does not require a value.
T-Mobile	<i>fast.t-mobile.com</i>	The operator does not require a value.	The operator does not require a value.

Table 33 – Telecom Operators

LogBox 3G features the  symbol, which informs the mobile network status. It also has a screen that provides more detailed data on the mobile network connection (see [Display Information](#) and [Navigation Screens](#) sections).

For the mobile network interface to operate correctly with data connection services, a SIM Card with an active data plan needs to be connected. For the mobile network interface to operate with SMS services, a SIM Card with an active SMS plan needs to be connected.

15.2.1 DIAGSIM APPLICATION

LogBox 3G has an application to help you perform tests and detect possible problems in the SIM Card used in your device. Available for Android smartphones, the **DiagSIM** application can be downloaded for free from *Google Play Store*.

To start a diagnostic, you need to insert the **LogBox 3G** SIM Card into the smartphone, as shown in the figure below:

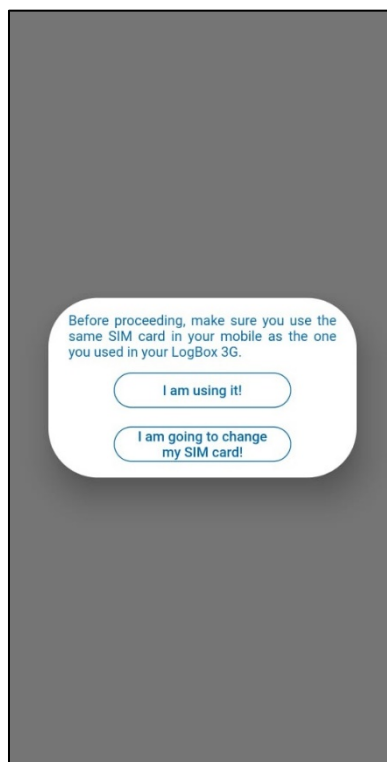

Figure 47 – SIM Card Diagnostic application

In addition, your smartphone must be connected to a 3G network. Otherwise (and after confirming that you are using the same SIM Card as the **LogBox 3G**, as requested in the previous figure), the **DiagSIM** application will display the following home screen:



Figure 48 – Home screen while connected to a Wi-Fi network Figure 49 – Home screen while connected to a 2G, 4G or 5G network

While connected to a Wi-Fi, 2G, 4G or 5G network, it is still possible to send the test SMS, a process that will be shown in more detail below. To start the diagnostic process, however, you must be connected to a 3G network.

After switching to a 3G network, you will need to restart the application, which will then display the following home screen:

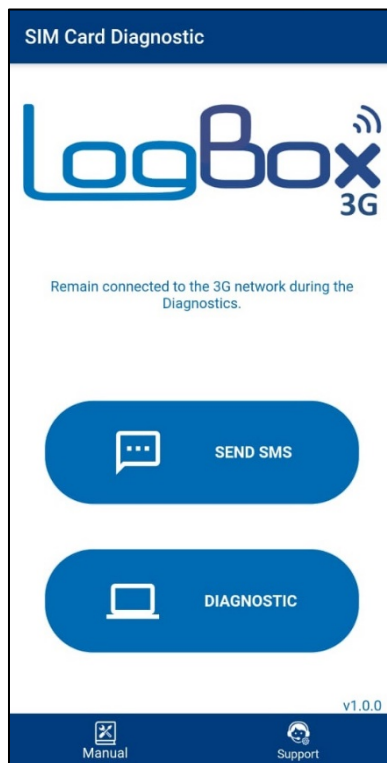

Figure 50 – Home screen while connected to a 3G network

The application has 2 buttons, as shown in the previous figures: **Send SMS**, which allows you to send a verification code via SMS to the registered phone number, and **Diagnostic**, which allows you to check problems in the SIM Card used. In addition, it also has 2 icons: **Manual**, which takes you to the device manual webpage, and **Support**, which takes you to **NOVUS**' Technical Support webpage.

When clicking on the **Send SMS** option, the application will request a conformation to send a SMS with a verification code. To do so, you must enter your phone number:

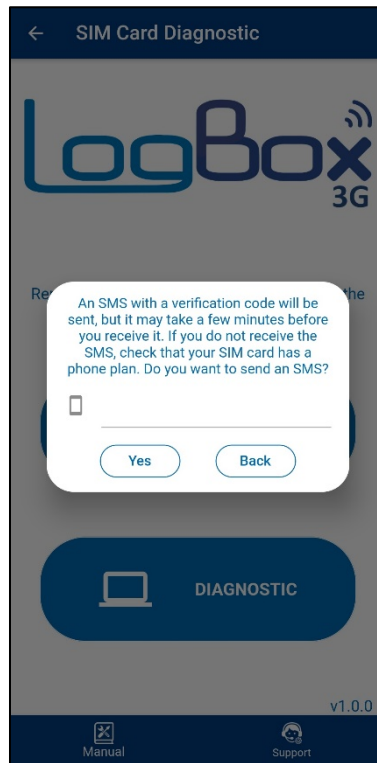

Figure 51 – Confirmation to send SMS

As previously informed, it may take a few minutes to receive the SMS. You also need to have an SMS package contracted. Upon receiving the SMS, the application will display the following message:

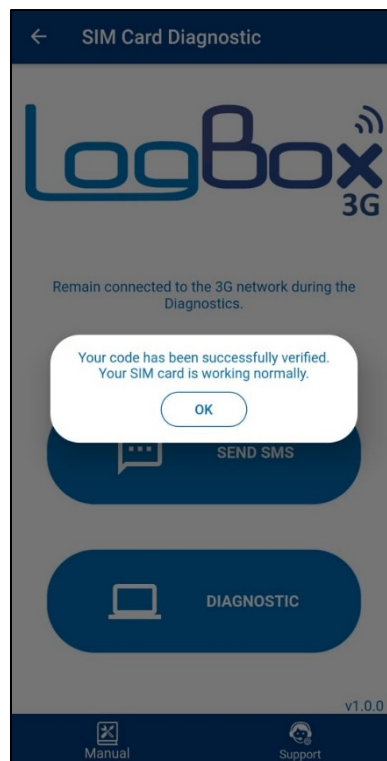

Figure 52 – Verified code

To perform SIM card diagnostics, in turn, simply click on the Diagnostics button. Before the diagnostic, you will need to enter the serial number of the device:

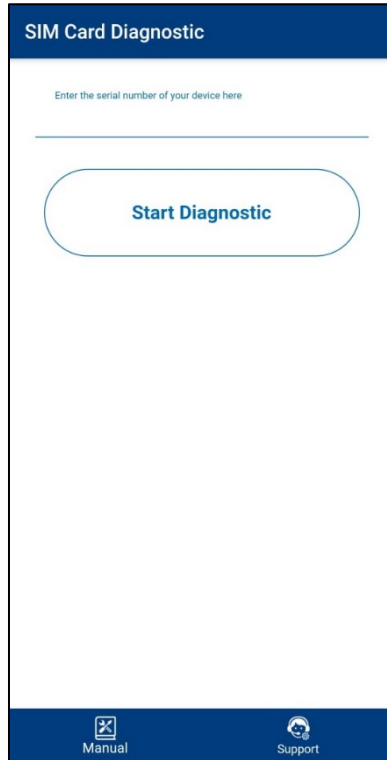

Figure 53 – Device serial number

When you start the diagnostic, the application will show you a log of the tests currently being performed (such as testing Internet connection and trying to get the device Token from **NOVUS Cloud**, for example):

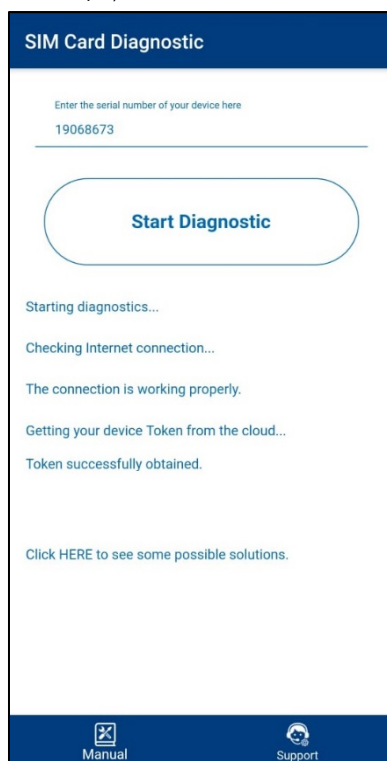

Figure 54 – Diagnostic

If the diagnosis has been performed successfully, it is likely that the difficulties you have encountered are not related to the SIM card used. In this case you can view some solutions by clicking on the **Click HERE to see some possible solutions** option, as shown in the figure above.

The application will display a list of suggested items to check:

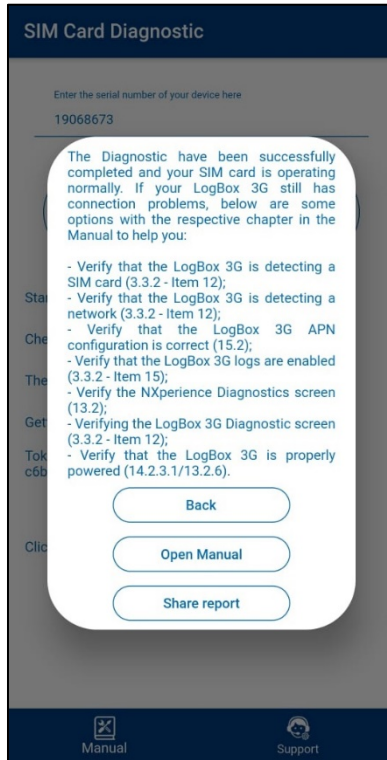

Figure 55 – Suggestions

From there you can go back to the previous screen, open the device manual, or share the diagnostic report via the Android file sharing options. The diagnostic report will be generated in .txt format, as shown in the figure below:



Figure 56 – Report

If the application cannot get the Token from the device, it will display the following warning:

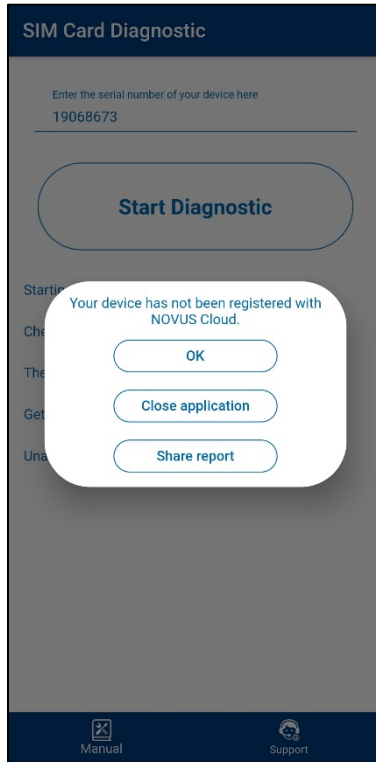

Figure 57 – Unregistered device

If the SIM card does not have Internet access, the application will display the following warning:

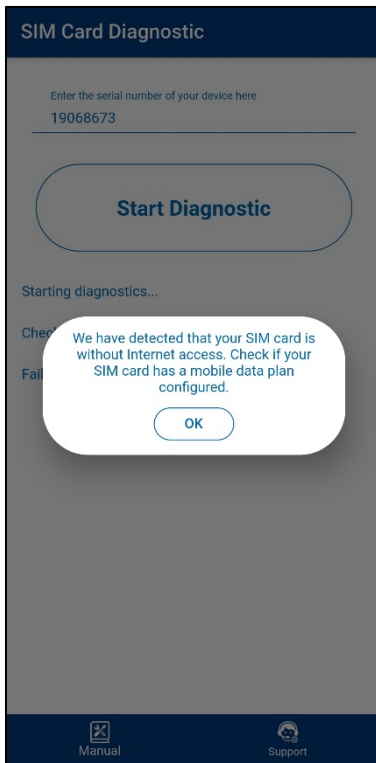

Figure 58 – SIM Card without Internet access

16. TROUBLESHOOTING

16.1 START/STOP MODES

Depending on the Start/Stop rule configured in the device, it may lose information if it is to continue logging after a power outage or not.

- Logging start and end modes "By Keyboard", "By Software" or "By Digital Input" may be lost when the device is powered on.
- "Immediate Start", "Date/Time" or "Daily" logging start and end modes will resume when the device is powered on again and is able to restart the clock.

16.2 CLOCK

If date/time syncing is disabled, the device will use the user-configured date/time, not correcting it until a new configuration is applied. As such, in the event of a power outage, **LogBox 3G** will not be able to reset the clock on its own. The device will thus not record anything until the clock is reconfigured.

If automatic syncing is enabled, the device will automatically resume data logging and publication after power returns.

16.3 ALARM INFORMATION

Alarm information, maximum and minimum values reached in each channel, as well as date/time of the last event are data that can be lost if the device remains powered off for more than 30 minutes. The data logged at the logging frequency or the digital input events, if configured for "Event Logging", are the only data that are will not be lost (unless a new configuration is applied, or the user chooses to clear the memory).

NXperience has the function of reporting the maximum and minimum logged values, as well as indicating the logs in alarm condition.

16.4 MOBILE NETWORK INTERFACE

- If the mobile network interface signal is poor or not working, the following possibilities should be checked:
 - Make sure the mobile antenna is connected to the right place, always at the first side slot.
 - Check whether there is a data plan contracted for the SIM Card inserted in the device.
 - Check whether there is any problem with the SMS plan.
 - Check whether the device is in an area without coverage.
 - Check whether the SIM Card is presenting any loose contact problems.
 - Check to see if the SIM Card is burned.
 - Check the APN connection required by the operator.
 - Check whether the USB cable is connected and if the device is not connected to an external power supply. The mobile network interface does not operate in these conditions.
- If the device is running on backup battery, the mobile network module will be turned off as soon as the battery reaches a level below 1%. This measure aims to prolong battery duration and allow the device to continue logging. For the mobile network module to resume operation, the device must be powered by an external power supply.
- If the wireless symbol is off or flashing, see [Display and Navigation](#) chapter.
- To perform a diagnostic on the SIM Card used in **LogBox 3G**, use the **SIM Card Diagnostic** application (see [DiagSIM Application](#) section).

16.5 GPS INTERFACE

- If the GPS interface signal is poor or not working, the following possibilities should be checked:
 - Make sure the GPS antenna is connected to the right place, always at the second side slot.
 - Check whether external climate and bad weather are interfering with proper functioning of the GPS interface.
 - Make sure the device is not located somewhere with roofing or shadow from buildings or mountains could interfere with proper functioning of the GPS interface.
 - Check whether the USB cable is connected and if the device is not connected to an external power supply. The GPS interface does not operate in these conditions.
- If the device is running on backup battery, the GPS module will be turned off as soon as the battery reaches a level below 1%. This measure aims to prolong battery duration and allow the device to continue logging. For the GPS module to resume operation, the device must be powered by an external power supply.

16.6 BACKUP POWER BATTERY

If the device temperature is below or above the specification (see [Technical Specifications](#) chapter), the backup battery will not charge.

If it is noted that the battery is no longer able to retain charge, it is recommended to leave the device on and without a SIM card for at least 24 hours. Check the battery operation after this period. Having been unable to return to normal, contact the manufacturer or authorized service provider to perform the replacement.

The backup battery may present fluctuations due to the device's mobile data communications (when the device communicates via mobile network interface, the battery voltage and percentage will naturally fall). The device will shut down automatically when it detects that the voltage has dropped to a critical level.

When running on backup batteries, the mobile network module will be turned off as soon as the battery reaches a level below 1%, thereby prolonging its duration and allowing the device to continue logging. For the mobile network module to resume operation, the device must be powered by an external power supply.

16.7 ANALOG INPUTS

- When a device that is connected to the mains (a thermocouple or voltage simulator, for example) is used in the analog inputs and is not isolated, using a reading interface other than USB is recommended. In some cases, due to the influence of the USB cable connection, noise and offsets have been detected in the reading.
- Configuring the local grid frequency (50 Hz or 60 Hz) is important for improving the performance of analog channel reading, even if the device is running on battery power. Usually, the power grid causes interference, which can be more easily mitigated if its frequency is known in the signal read by the sensors.

16.8 UNREGISTERED ALARMS

The alarm status information, as well as the maximum and minimum values reached in each channel, is refreshed by any events that trigger an acquisition, which may be readings during the logging interval or the display refresh interval. If a channel reaches a minimum or maximum value or an alarm condition during an acquisition other than the logging interval, it may not be logged in the memory. As such, statuses may indicate that the channel has already reached one of these situations and that the information is not available in a download.

The logging interval must be configured according to the maximum period allowed by the process being monitored, so that no important information is lost (or stops being logged).

16.9 LIMIT OF EVENTS SENT BY SMS

Sending a SMS is a relatively slow process that takes an average of 5 seconds to send each SMS to each recipient. LogBox 3G has a circular queue of 15 events for sending SMS. When more than 15 simultaneous events occur, the oldest ones will be discarded to give place to the new ones.

All events will be treated, although it may be possible that, in certain circumstances, not all SMS will be sent (see [SMS](#) chapter).

16.10 FIRMWARE RECOVERY

- If you need to recover the firmware after problems in updating it, follow the steps below:
 - Try to perform the firmware update process again.
 - If the device is not being recognized in the **NXperience** list of devices, use the shortcut Ctrl + F12 on the software home screen to update.
 - If the previous procedure did not work, turn the device off and on again, holding down both keys – which will initialize the Bootloader mode. Use the shortcut described above to access the **NXperience** firmware update screen.

16.11 PROBLEMS COMMUNICATING WITH THE DEVICE VIA USB INTERFACE OR DURING FIRMWARE UPDATE

If you have problems communicating the device via the USB interface or there are problems during firmware update, it is recommended to perform the following procedure to speed communication and minimize incompatibility issues:

- a. Open the Device Manager:

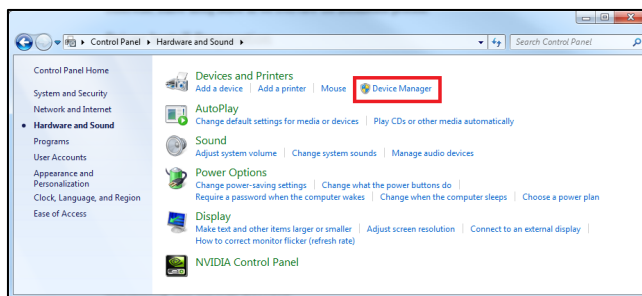

Figure 59 – Device Manager

- b. Open the COM port setting of the device:

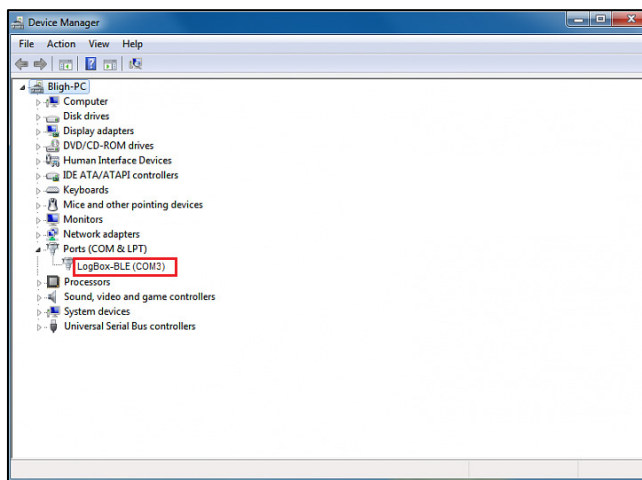

Figure 60 – Device Manager

c. Open advanced COM port configuration options:

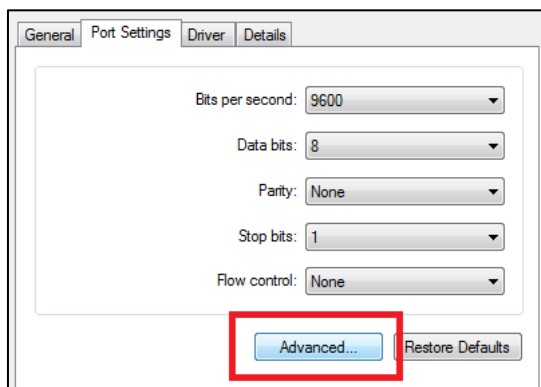

Figure 61 – Port settings configuration

d. Uncheck the **Use FIFO buffers** option:

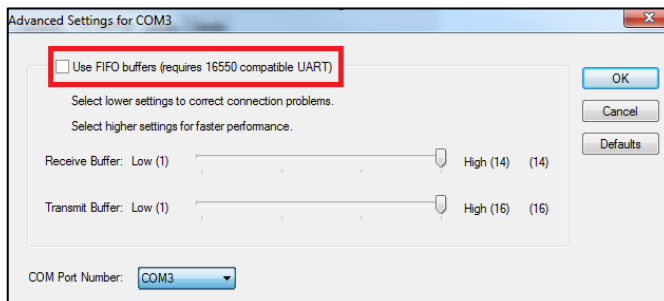

Figure 62 – Advanced settings

16.12 FIRMWARE UPDATE

If there are problems during the firmware update, it is recommended to perform the following procedure:

- Before upgrading the firmware, verify if the latest version of **NXperience** has been installed.
- If a failure occurs during firmware update, the following message will be displayed:

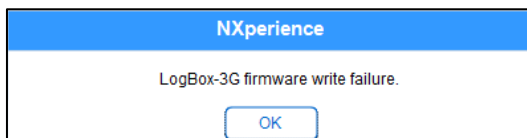

Figure 63 – Firmware failure

c. Click **OK** and verify if the device is still available for the update. If it is, click on **Program** again:

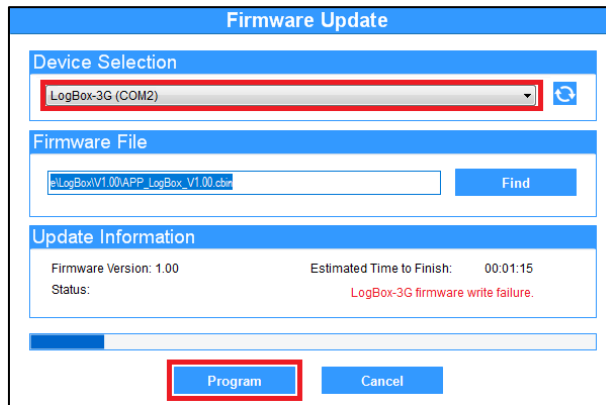

Figure 64 – Firmware update

- d. If **NXperience** has been closed and/or it is no longer possible to find the device on the update screen, as shown in the figure below, it is necessary to close the **NXperience**, turn off the **LogBox 3G** and reconnect the device to the USB interface for a new attempt.

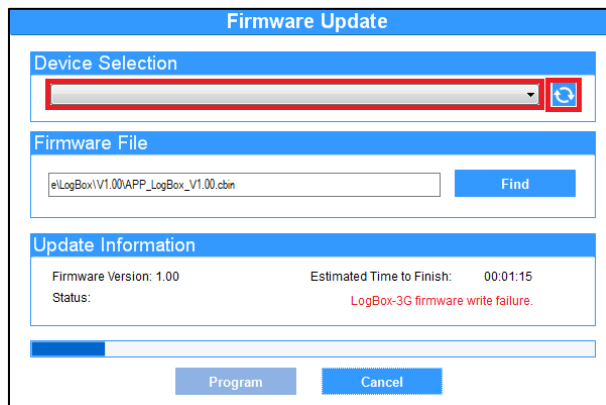

Figure 65 – Firmware failure

- e. If the **NXperience** shows an error while reading the configuration, as shown in the figure below, and the device display is off, try the procedure described in the following step.

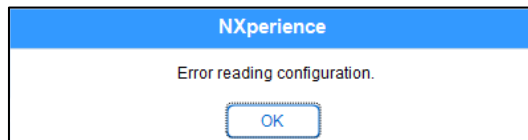

Figure 66 – Error reading configuration

- f. On the **NXperience** startup screen, as shown in **Figure 55**, pressing the Ctrl + Shift + F12 keys simultaneously will cause the firmware update screen to reappear, as shown in **Figure 56**.

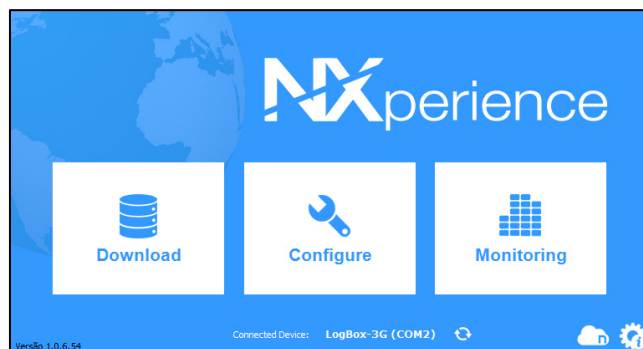

Figure 67 – NXperience home screen

The screenshot shows a 'Firmware Update' dialog box. It has a blue header with the text 'Firmware Update'. Below the header, there are three main sections: 'Device Selection' with a dropdown menu and a refresh icon; 'Firmware File' with a text input field and a 'Find' button; and 'Update Information' with labels for 'Firmware Version:', 'Estimated Time to Finish:', and 'Status:'. At the bottom, there are 'Program' and 'Cancel' buttons.

Figure 68 – Firmware update

- g. Try to update the firmware again.
- h. If you cannot find the device in **Step F**, turn off the **LogBox 3G** and switch it back on by holding down both keys. After that, repeat **Step F**.
- i. In case of failure during previous procedures, contact **NOVUS** technical support.

17. TECHNICAL SPECIFICATIONS

CHARACTERISTICS	LOGBOX 3G	
Input Channels	2 Analog 1 Digital	
Compatible Analog Signals	Thermocouple J, K, T, N, E, R, S and B, Pt100, 0-50 mV, 0-5 V, 0-10 V, 0-20 mA, 4-20 mA	
Internal Measurements	Internal Temperature (NTC) Battery Voltage External Power Supply Voltage	
Analog Channel Input Impedance	Thermocouples / Pt100 / mV: > 2 MΩ mA: 15 Ω + 1.5 V V: 1 MΩ	
Pt100	Maximum compensation cable resistance: 25 Ω Excitation current: 166 μA Curve used: α= 0.00385	
Digital Input	Logical levels	Logical Level "0": from 0 to 0.5 VDC Logical level "1": from 3 to 30 VDC
	Maximum Voltage	30 Vdc
	Input Impedance	270 kΩ
	Input Current @ 30 VDC (typical)	150 μA
	Maximum Frequency (square wave)	Dry Contact: 10 Hz, PNP: 2 kHz, NPN: 2 kHz
	Minimum Pulse Duration	Dry Contact: 50 ms, PNP: 250 μs, NPN: 250 μs
Digital Output	1 NPN-type output Maximum current that can be switched at output: 700 mA	
Display	3 lines, 4½ digits	
Resolution	Analog Signals: 15 bits (32768 levels) Digital Signal: 16 bits (65536 levels)	
Memory Capacity	140,000 logs (total)	
Logging Interval	1 second to 12 hours (recommended: 300 seconds)	
Log Type	Instant or Medium	
Log Trigger	Date/time, keypad, digital input, software command or SMS	
Alarms	10 alarms available (they may trigger the digital output, internal buzzer and send SMS)	
Internal Buzzer	Yes, it can be used for alarms	
Communication Interfaces	USB Mobile network module (2G, 3G, SMS)	
Software	NXperience (for desktop and notebook computers - locally via USB or remotely via NOVUS Cloud)	
GPS	Available for models with GPS	
Power supply	Power Supply	Voltage: 10 VDC to 30 VDC Maximum Consumption: 700 mA Typical Consumption: 70 mA
	Backup Batteries	1 or 4 internal batteries depending on model*
Estimated Backup Battery Life	Typically 2 hours for the model with 1 battery Typically 8 hours for the model with 4 batteries	
Operating Temperature	Using Power Supply: -20 to 60 °C ** Using Backup Power: 0 to 45 °C ***	
Enclosure	ABS+PC	
Protection Rating	IP40	
Dimensions	120 x 100 x 40 mm (without antenna)	

Table 34 – Technical specifications

* Risk of explosion: Internal batteries may only be replaced by the manufacturer or authorized service provider.

** Risk of explosion: Be careful with the device's operating temperature. Extremely high or low temperatures can cause ruptures and leaks in backup batteries and cause damage.

*** Backup batteries will be charged only while the device is operating in the temperature range from 0 to 45 °C.

17.1 SENSOR RANGE AND ACCURACY

	Sensor	Minimum Sensor Value	Maximum Sensor Value	Sensor Resolution	Accuracy (%)
Thermocouples	J	-100.0 °C -148.0 °F	760.0 °C 1400.0 °F	0.1 °C 0.2 °F	0.15 % (F. S.) ± 1 °C
	K	-150.0 °C -238.0 °F	1370.0 °C 2498.0 °F	0.1 °C 0.2 °F	0.15 % (F. S.) ± 1 °C
	T	-160.0 °C -256.0 °F	400.0 °C 752.0 °F	0.1 °C 0.2 °F	0.15 % (F. S.) ± 1 °C
	N	-270.0 °C -454.0 °F	1300.0 °C 2372.0 °F	0.1 °C 0.2 °F	0.15 % (F. S.) ± 1 °C
	E	-90.0 °C -130 °F	720.0 °C 1328.0 °F	0.1 °C 0.2 °F	0.15 % (F. S.) ± 1 °C
	R	-50.0 °C -58.0 °F	1760.0 °C 3200.0 °F	0.3 °C 0.5 °F	0.15 % (F. S.) ± 1 °C
	S	-50.0 °C -58.0 °F	1760.0 °C 3200.0 °F	0.4 °C 0.7 °F	0.15 % (F. S.) ± 1 °C
	B	500.0 °C 932.0 °F	1800.0 °C 3272.0 °F	0.4 °C 0.7 °F	0.15 % (F. S.) ± 1 °C
Pt100	Pt100	-200.0 °C -328.0 °F	650.0 °C 1202.0 °F	0.1 °C 0.2 °F	0.15 % (F. S.)
Linear	0 to 50 mV	0.000	50.000	0.003 mV	0.15 % (F. S.)
	0 to 5 V	0.000	5.000	0.6 mV	0.15 % (F. S.)
	0 to 10 V	0.000	10.000	0.6 mV	0.15 % (F. S.)
	0 to 20 mA	0.000	20.000	0.001 mA	0.15 % (F. S.)
	4 to 20 mA	4.000	20.000	0.001 mA	0.15 % (F. S.)
Digital Input	Count Mode	0	65535		0.01 % (F. S.)
Internal Sensors	Temperature (NTC)	-40 °C -40 °F	125.0 °C 257.0 °F	0.1 °C 0.1 °F	0.15 % (F. S.) ± 1 °C
	Battery Voltage	3.6	6.5	0.01 V	2 % (F. S.)
	External Power Supply Voltage	10.00	30.00	0.01 V	2 % (F. S.)

* F. S. = Full Scale = Span

Table 35 – Sensor range and accuracy

Accuracy: The sensor accuracy reading is measured in relation to Full Scale and is proportional to the maximum range measured at each sensor. For a Pt100 sensor, for example, in which **LogBox 3G** can read in the range from -200 °C to 650 °C, with 0.15 % precision, the accuracy in °C will be (650 °C -200 °C) * 0.15 % = 1.28 °C.

Thermocouples: The analog input circuit for **LogBox 3G** ensures the specified accuracy in the thermocouple sensor reading with a maximum cable impedance of 100 Ω . Thermocouple sensors with impedance above 100 Ω are read by **LogBox 3G**. Accuracy, however, is not guaranteed. For reading thermocouple sensors, **LogBox 3G** uses the internal temperature sensor for Cold Joint compensation. Just like the internal temperature sensor, thermocouples may present a greater error than specified when there are sudden variations in ambient temperature. The specified accuracy is only guaranteed when the device is installed in an environment with stable temperature for longer than one hour.

Pt100: The **LogBox 3G** analog input circuit guarantees the accuracy specified in reading PT100 type sensors with a maximum cable resistance of up to 25 Ω . The device can read sensors with cables that have resistance above 25 Ω , but in these cases, the accuracy and measurement range are not guaranteed. **LogBox 3G** performs the cable resistance compensation internally if it is equal in the three wires connecting the device to the sensor.

Linear 0 to 50 mV: The analog input circuit for **LogBox 3G** ensures the specified accuracy when reading electrical voltage magnitudes from 0 to 50 V and with a maximum cable impedance of up to 100 Ω . Voltage sources with series impedance above 100 Ω can be read by **LogBox 3G**. Accuracy, however, is not guaranteed.

Linear 0 to 5 V and 0 to 10 V: The analog input circuit for **LogBox 3G** ensures the specified accuracy when reading electrical voltage magnitudes from 0 to 5 V and 0 to 10 V with a maximum cable impedance of up to 200 Ω . Voltage sources with series impedance above 200 Ω can be read by **LogBox 3G**. Accuracy, however, is not guaranteed.

Linear 0 to 20 mA and 4 to 20 mA: All **LogBox 3G** input channels have common grounding between each other and with the power supply. Hence, for **LogBox 3G** to be able to correctly measure current transmitters, they need to be powered by isolated sources or by using all current transmitters with the grounding interconnected.

Digital Input: All **LogBox 3G** input channels have common grounding between each other and with the power supply. For **LogBox 3G** to correctly measure the digital input sensor, this characteristic must be considered. For correct detection of the logical levels of the sensor connected to the digital input, the maximum series impedance with the sensor should be less than 10 k Ω .

Internal Temperature Sensor: **LogBox 3G** has an NTC-type internal temperature sensor that can be used for monitoring ambient temperature. This sensor is used for the Cold Joint compensation of thermocouples. Because it is located inside the device's casing, it may present a greater error than specified when there are abrupt variations in ambient temperature. The specified accuracy is only guaranteed when the device is installed in an environment with stable temperature for longer than one hour. The sensor allows for readings in a range from -40 $^{\circ}\text{C}$ to 125 $^{\circ}\text{C}$. The temperature, however, is limited to the device's operating range.

17.2 CERTIFICATES

FCC

Contains FCC ID: N7NHL8549G

This device has been tested and found to comply with the limits for a Class A digital device, pursuant to Part 15 of the FCC Rules. These limits are designed to provide reasonable protection against harmful interference when the device is operated in a commercial environment. This device generates, uses, and can radiate radio frequency energy and, if not installed and used in accordance with the instruction manual, it may cause harmful interference to radio communications.

Any changes or modifications not expressly approved by the party responsible for compliance could void the user's authority to operate this device.

RF Exposure: To satisfy FCC RF exposure requirements, a separation distance of 20 cm or more should be maintained between the antenna of this device and persons during operation. To ensure compliance, operations at closer distances than this are not recommended. This device and its antenna(s) must not be co-located or operating in conjunction with any other antenna or transmitter.

This device complies with part 15 of the FCC Rules. Operation is subject to the following two conditions: (1) This device may not cause harmful interference, and (2) this device must accept any interference received, including interference that may cause undesired operation.

CE Mark / UKCA

This is a Class A device. In a domestic environment, this device may cause radio interference, in which case the user may be required to take adequate measures.

IC

Contains IC: 2417C-HL8549G

This device complies with Industry Canada's license exempt RSS standard(s). Operation is subject to the following two conditions: (1) This device may not cause interference, and (2) This device must accept any interference, including interference that may cause undesired operation of the device.

The installation of the transmitter must ensure that the antenna has a separation distance of at least 20 cm from all persons or compliance must be demonstrated according to the ISED SAR procedure.

Under Industry Canada regulations, this radio transmitter may only operate using an antenna of a type and maximum (or lesser) gain approved for the transmitter by Industry Canada. To reduce potential radio interference to other users, the antenna type and its gain should be so chosen that the equivalent isotopically radiated power (EIRP) is not more than that necessary for successful communication.

ANATEL

This device is homologated by ANATEL, according to the regulated procedures for conformity assessment of telecommunications products, and meets the technical requirements applied.

This equipment is not subject to the protection from harmful interference and may not cause interference with duly authorized systems.

For more information, see ANATEL website www.anatel.gov.br.

VIBRATION TEST

The device is in accordance with vibration tests in sinusoidal vibration methods - item 6.1 and mechanical shock - item 6.2 of norm NP EM 12830 (2008).

18. WARRANTY

Warranty conditions are available on our website www.novusautomation.com/warranty.